

1/18 ASPHALT MODIFIED

Quick Start Guide & Instruction Manual



#1RC1130

#1RC1131

#1RC1132

Before operating this model, please read this entire Quick Start Guide/Instruction Manual and all printed materials related to this model. Read and follow all warnings and precautions. Failure to follow all warnings and precautions while operating this model could result in personal and/or property damage. This model can be harder to drive than other models due to narrower tires.

SAFETY PRECAUTIONS

- WARNING—CHOKING HAZARD—SMALL PARTS—NOT FOR CHILDREN UNDER 5 YEARS OLD.
- THIS RADIO CONTROLLED RACING CAR IS NOT A TOY!
- THIS HIGH-PERFORMANCE R/C MODEL IS RECOMMENDED FOR AGES 14 AND OLDER.
- THIS IS ONLY FOR YOUR REFERENCE BEFORE YOU OPERATE THE MODEL CAR.
- PLEASE DO NOT CHANGE THE EQUIPMENT OF THE BRUSHLESS ESC, MOTOR AND BATTERY CASUALLY, WE WILL NOT TAKE ANY CHARGE OF THE DAMAGES OR INJURIES CAUSED BY YOUR CHANGES!
- ASSEMBLE THIS KIT ONLY IN PLACES OUT OF CHILDREN'S REACH!
- TAKE ENOUGH SAFETY PRECAUTIONS PRIOR TO OPERATING THIS MODEL. YOU ARE RESPONSIBLE FOR THIS MODELS ASSEMBLY AND SAFE OPERATION!



FIND AND FOLLOW
US HERE

WWW.1RC-RACING.COM

E-mail—support@1rc-racing.com

900-0024 Rev B

Safety Precautions and Warnings

Please read all warnings and precautions in this Quick Start Guide/Instruction Manual along with any other documentation provided for this model. Failure to operate your model in a responsible and safe manor may result in personal property damage and/or personal injury. As the user of this model, you are solely responsible for operating the model in a safe manor. 1 RC Racing, LLC shall not be liable for any loss or damages, direct, indirect, special, incidental, or consequential that occurs during the use, misuse, or abuse of this vehicle or any product required to operate it.

- **WARNING—CHOKING HAZARD—SMALL PARTS—NOT FOR CHILDREN UNDER 5 YEARS OLD.**
- This radio controlled racing car is not a toy! This car can be harder to drive than other models due to narrower tires.
- This high-performance R/C model is recommended for ages 14 and older.
- This is only for your reference before you operate the model car.
- Do not change the equipment of the brushless ESC, motor and battery casually, we will not take any charge of the damages or injuries caused by your changes!
- Assemble the kit only in places out of reach of children's reach!
- Take enough safety precautions prior to operating this model. You are responsible for this models assembly and safe operation.
- This model contains many small parts that could cause a choking hazard, keep all part away from children.
- This model is intended for smooth track use only, this model is not intended for off-road use. Track surface should be smooth with minimal bumps.
- Never operate your model with low transmitter and/or model batteries.
- This model is controlled by a radio signal that could be subject to interference from many sources outside your control. This interference may result in the loss of control so ensure you as the operator of this model always keep some distance in all directions around your model as a safety margin to avoid personal and/or property damage to you and others in the area.
- Never operate your model in a public street or congested area and always keep away from cars, traffic and crowds of people.
- Never operate your model at night or anytime line of sight may be obstructed or impaired in any way.
- This model is small so ensure you run your model in a non crowded area so nobody trips on model.
- This model is small and could be a trip hazard, ensure you only run the car in a safe area.
- This model is not waterproof, ensure vehicle is not run in wet conditions.
- Always turn on your transmitter first, then model.
- Do not put fingers on or near any moving part, this may result in serious injury or damage model.
- After running model, NEVER touch items like motor, battery, or electronic speed control as these items may be hot and result in serious injury as they may generate high temperatures during operation.
- When you are done using model, turn off model first, then transmitter.
- Never store model with battery installed or plugged in, always ensure battery is unplugged and removed before storage. Store battery in safe place.
- Never leave battery on charger for more than 1 hour and always unplug charger from wall when not in use. Never charge a battery that is hot or damaged.
- Some details and images in this manual might not exactly reflect the items you find in you model box.

Table of Contents	Page
Safety Precautions and Warning and Contents	2-3
Quick Start	4
Battery Charging	4-5
Battery Installation	5
Transmitter Operation and ESC/Rx Tuning	6-8
Troubleshooting	9
Replacement Parts Listing and Exploded Views	10-12
Set-up Tips and Notes	13



Contents

- 1/18 Asphalt Modified Car
- Transmitter
- Battery (for model)
- USB Battery Charger (for model battery only)
(USB power port not included)
- 4 AA Batteries (for transmitter)
- L - Allen Wrench
- Nut Driver
- Manual and Sticker Sheet
- Bind Plug

Quick Start

Before operating your model, please read entire manual to ensure you have complete understanding how to operate and control vehicle.

1. Read all safety precautions and warnings in this manual.
2. Charge the model battery as described below. Read all safety precautions and warnings about charging battery.
3. Install AA batteries in transmitter as described on the next page of this manual. Only use alkaline batteries in transmitter.
4. After model battery is fully charged, ensure switch is in off position on model and then install model battery as detailed below in this manual.
5. Turn on transmitter and then with model in safe location away from others, turn on model. Wait at least 5 seconds for transmitter and model to bind together.
6. Ensure steering and throttle is working correct and ensure steering is moving front tires in correct directions.
7. Drive model while adhering to all safety precautions and warnings detailed in this Quick Start Guide/ Instruction Manual.
8. When you are done using model, turn off model first, then transmitter, then remove battery from model and store in safe location before next use. NEVER store battery in model.

Safety Data—NiMH Battery



WARNING: USER MUST READ AND FOLLOW ALL INSTRUCTIONS AND WARNINGS AND PRECAUTIONS.



WARNING: This battery is not a toy and care should be taken when handling and charging the battery. Failure to do so could result in serious injury to user and others in the area. Details listed below must be followed to ensure no harm is done to persons and property.

Handling and Storage

- Never drop battery.
- Never alter battery in any way.
- Never puncture battery.
- Never short circuit battery by connecting terminals.
- Never leave battery in model.
- Never leave battery connected to model or charger after use.
- Always store battery in dry cool location.
- Always store battery in safe battery storage bag.
- Keep battery away from water.

Charging Battery

- Always make sure battery is not damaged before charging.
- Only use charger that is specifically designed for battery.
- Refer to charger instructions for charging details.
- Never charge a battery that is hot to the touch.
- Remove battery from charger if battery becomes hot to the touch.
- Battery will take about 30-45 minute to fully charge. Do not leave battery on charger more than 1 hour.

Safety

1 RC Racing, LLC is not liable for the misuse or mistreatment of this battery, all warnings and precautions must be followed to ensure safe use. In the event a battery becomes hot to the touch or starts to smoke or outer covering starts to melt while charging/running or you see any change in the battery condition, remove battery from charger or model and then safely move battery to a safe location in open outside air away from any persons and property. Leave battery in outside open area for at least 2 hours to allow battery to cool and stabilize. Once battery has cooled and is no longer a danger, store battery in plastic sealed container to eliminate any shorting and then battery must be recycled. Do not store battery with other waste. Call your local recycling center for information on battery recycling in your area. Handle any damaged battery with great care, batteries are corrosive so ensure damage batteries and its contents never contact skin in any way. If skin comes in contact with damaged battery, immediately wash the affected area with soap and contact medical care if additional care is needed. If damaged battery or its contents contact your eyes in any way, wash with water for at least 15 minutes and then contact medical care

Battery Charging — USB Battery Charger (USB power port not included)

Caution: ONLY charge 5 cell NiMh battery with included charger, NEVER charge 4 cell NiMh battery with included charger. Never charge a battery that is hot or damaged. Never leave battery on charger for more than 1 hour. Always unplug battery charger from battery and USB power port when not in use. Always remove the battery from the model before charging, NEVER charge the battery in the model. Always use charger that came with model to charge model battery ONLY. Never store battery in model when not in use, always store battery in safe place when not in use. Never plug battery in backwards to charger or damage will occur. Always avoid contact with water or other liquids.

Directions—1. Plug charger into a suitable USB power port like a smartphone charger (USB power port not included). 2. Connect battery to charger as shown below, ensure you do not plug it in backwards. 3. Light will start to flash slowly on charger when battery is connected, this indicates battery is charging. Battery will take around 30-45 minutes to fully charge. If light on charger does not flash slowly, this means battery is already charged 4. Once light stops flashing on charger, that indicates battery is charged, remove battery from charger and unplug charger from power source.



Step 1 - Plug in USB Charge

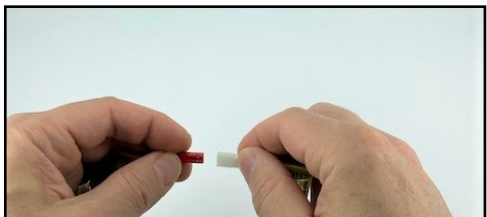

Step 2 - Connect Battery to Charger

Battery Installation

Caution: Never store battery in model when not in use, always store battery in safe place when not in use. Never plug battery in backwards to charger or model or damage will occur. Always avoid contact with water or other liquids. Always remove the battery from the model before charging, NEVER charge the battery in the model. After battery is installed in model, ensure lock tab on battery box is fully locked to ensure battery does not come out of model.



Step 1 - Plug Battery into Model



Step 2 - Insert Battery into Model



Step 3 - Close Battery Door

Safety Precautions and Warnings

- This radio is not a toy and should not be operated by anybody under 14 years of age. Adult supervision is required.
- Always ensure radio is on before turning on car or injury or damage can occur.
- Always perform system check to ensure throttle and steering is working correct before operating.
- Do not mix old and new batteries. It is recommended to use only alkaline batteries.
- Do not operate radio in rain or wet environment.
- Ensure Failsafe function is set before operating vehicle.
- Do not hold transmitter by antenna while operating, this will decrease performance.

Transmitter Operation

Caution: Never hold the trigger when turning on transmitter. Ensure you understand all features of transmitter before using. Do not drop transmitter or damage can occur.

Transmitter Features

1. **Steering Wheel:** Controls direction of model (left/right).
2. **Throttle Trigger:** Controls direction of model (forward/reverse).
3. **Power Switch:** Turns transmitter on and off.
4. **Power LED:** Indicates if transmitter is on or off.
5. **Power Check**
6. **Steering Trim:** Adjusts the centering of the models front tires.
7. **Steering Dual Rate:** Adjusts the amount the models front tires turn front right to left.
8. **Throttle Trim:** Adjusts the motors speed when trigger is at neutral position.
9. **Steering Reverse:** Switch that will reverse the direction of steering servo.
10. **Throttle Reverse:** Switch that will reverse the direction of the motor when trigger is moved.
11. **Bind Button:** Used to bind transmitter to receiver.
12. **Battery Door:** Remove door to install 4x AA batteries.

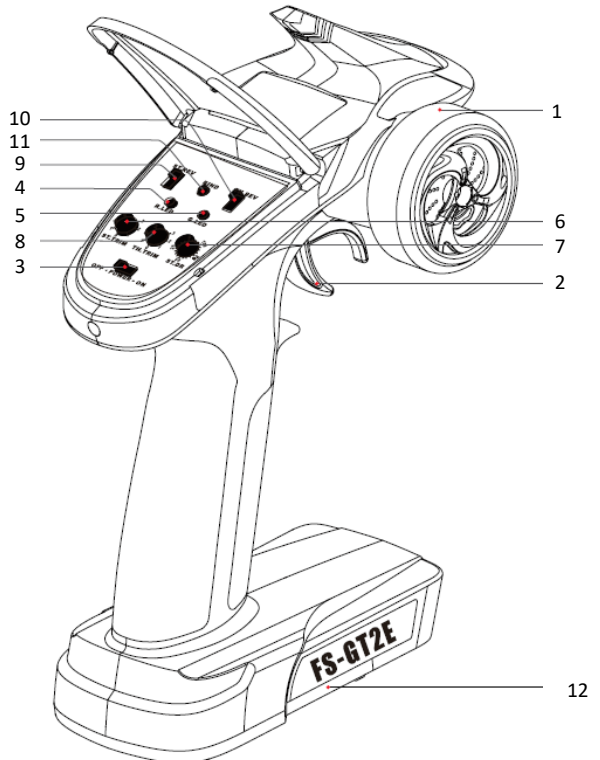

Binding Transmitter to Model

1. Plug in bind plug to Bind Port on receiver.
2. Turn on cars on/off switch (located on bottom of the car) and LED on receiver will start to flash rapidly.
3. On transmitter, hold down Bind Button (item 11 in the image on previous page) and turn on Power Switch (item 3 in image on previous page). Continue holding Bind Button until LED on receiver stops flashing and goes solid and then starts to flash slowly.
4. Then turn off car and transmitter and remove bind plug from receiver.
5. Turn transmitter on then turn car switch back on and check steering and throttle operation to ensure controls are working correctly.
6. If controls are not working correctly, turn off the cars switch and turn on transmitter and repeat steps 1-6.

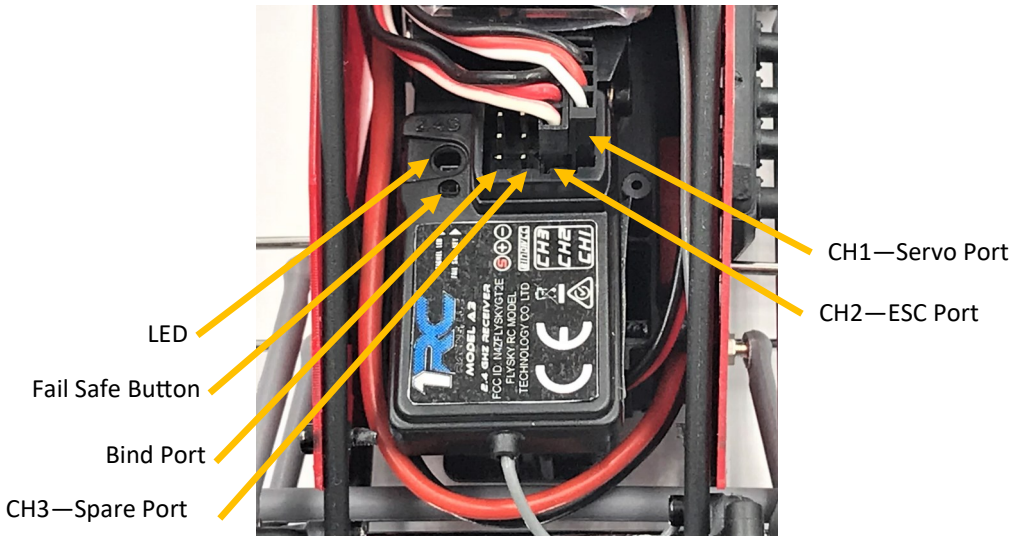

Failsafe Setting

The failsafe will help prevent an out of control situation if the transmitter signal is lost.

How to Set the Failsafe:

1. Turn on transmitter.
2. Turn on the receiver and ensure the LED on the receiver is on and solid.
3. Leave the throttle on the transmitter in the neutral position.
4. Using the Failsafe Setting Stick on the Bind Plug wire, press the Fail Safe Button on the receiver. The LED will blink and then stop after 3 seconds, that will indicate the failsafe is set.

Test the Failsafe:

1. Turn on transmitter.
2. Turn on the receiver.
3. Turn off the transmitter and ensure the cars rear wheels do not roll. If rear wheels roll repeat steps 1-4 in How to Set the Failsafe.

ESC (Electronic Speed Control)

WARNINGS

- USER MUST READ AND FOLLOW ALL INSTRUCTIONS AND WARNINGS AND PRECAUTIONS.

- ENSURE ALL WIRES AND CONNECTIONS ARE WELL INSULATED BEFORE CONNECTING THE ESC/Rx TO RELEATED DEVICES, AS SHORT CIRCUIT WILL DAMAGE THE ESC/Rx.

- ENSURE ALL DEVICES ARE WELL CONNECTED TO PREVENT POOR CONNECTION THAT MAY CAUSE YOUR VEHICLE TO LOSE CONTROL OR OTHER UNPREDICATABLE ISSUES SUCH AS DAMAGE TO THE DEVEICE.

- STOP USING THE ESC WHEN IT TEMPERATURE EXCEEDS 90°C/194°F, OTHERWISE YOUR ESC/Rx WILL BE DAMAGED AND MAY ALSO DAMAGE YOUR MOTOR. WE ALWAYS RECOMMEND SETTING THE "OVER

HEAT WARNING" TO "ENABLED" TO ENSURE DAMAGE DOES NOT OCCUR TO YOUR ESC/Rx UNIT.

- ALWAYS DISCONNECT THE BATTERIES AFTER USE, AS THE ESC WILL CONTINUE TO CONSUME CURRENT IF IT'S CONNECTED TO BATTERIES (even if the esc is turned off). LONG-TIME CONNNECTION WILL CAUSE BATTERY TO COMPLETELY DISCHARGE AND RESULT IN DAMAGE TO BATTERIES AND/OR ESC. THIS WILL NOT BE COVERED UNDER WARRENTY.

Setting ESC

1. Ensure battery is installed and ensure battery is connected to model and secured in battery tray area. Ensure battery is connected correctly or damage can occur to ESC/Rx unit.
2. Remove hood on model so you have full access to ESC/Rx unit.
3. Ensure car is elevated off ground so tires are not touching ground, this will prevent any damage if car starts to move during binding process.
4. On transmitter, make sure the throttle trim knob is set to 0, then turn on transmitter.
5. Hold ESC Set Button down while you turn on the model using the switch just behind the front axle from underside of model.
6. When ESC Red Light starts to flash, release the Set Button, ESC is now in setup mode.
7. With trigger on radio in neutral position, press Set Button one(1) time, ESC Red Light will stop flashing and green light will quickly flash once, this confirms the neutral position.
8. Now pull trigger to full throttle on transmitter and press Set Button again, ESC Green Light will flash twice to confirm full throttle setting, hold trigger in full throttle until light stops flashing.
9. Now push trigger to full brake on transmitter and press Set Button again, ESC Green Light will flash three time to confirm full brake setting, hold trigger in full brake until light stops flashing.
10. Return trigger on transmitter to neutral and ESC Green Light will brink two times. Your ESC and now set.
11. Ensure steering and throttle works correct, make adjustment to transmitter throttle trim knob so motor does not move when trigger on transmitter is in neutral position.
12. Ensure ESC it reaching full throttle, pull trigger to full throttle and ESC Green Light should go solid if full throttle is reached.

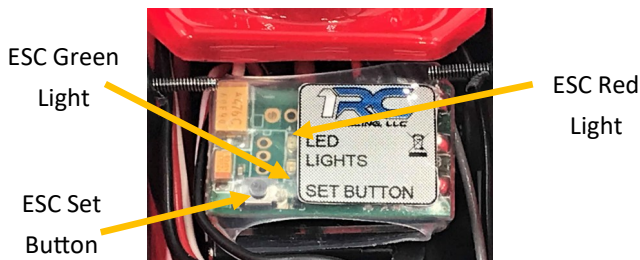

Troubleshooting

Description	Problem	Solution
Model has no power	Switch is not on	Turn transmitter and model switch on
	Battery is not charged	Charge battery
	Battery not plugged in	Plug in battery
	ESC/Rx failure	Replace ESC/Rx
	Tx not bound to Rx	Re-bind Tx to Rx
	Transmitter failure	Replace transmitter
Steering Servo does not work	Servo not plugged in	Plug servo into ESC/Rx unit
	Steering linkage bound up	Free up steering linkage
	Can hear servo moving but wheels do not turn	Check dual rate, servo saver and linkage from servo to front tires
	Servo failure	Replace servo
Car does not move when pulling throttle trigger on transmitter	Motor not plugged in	Plug motor in
	ESC out of adjustment	Reset ESC
	Wire unsoldered from motor	Re-solder wire to motor
	Motor Failure	Replace motor
	Motor Failure	Replace motor
Steering	Wheels turn wrong direction	Flip steering reverse switch on transmitter
	Servo gears damaged	Replace servo
Throttle	Car goes backward when pulling trigger on transmitter	Flip throttle reverse switch on transmitter then reset ESC
	No reverse	Reset ESC
	No brakes	Reset ESC
	Motor runs but car does not	Check all gears in transmission for damage
Model slows or stops while running	ESC/Rx overheating	Turn model if and let ESC cool down
	Motor overheating	Turn model off and let motor cool down
	Battery losing charge	Charge battery
	Tx not bound to Rx	Re-bind Tx to Rx
	Gear train bound up	Free gear train of obstructions
Model glitching	Transmitter batteries low	Replace transmitter batteries
	Model battery low	Charge model battery
	Loose wires	Check all wires on model

Replacement Parts

1RC1130	1/18 Asphalt Modified, Red, RTR	1RC5004	Shock Plastic Parts, 1/18 Mid, Spr, EDM
1RC1131	1/18 Asphalt Modified, Black, RTR	1RC5011	O-Rings, Clear, Shocks, 1/18 Mid, Spr, EDM, LM, AM
1RC1132	1/18 Asphalt Modified, Clear, RTR	1RC5549	FR/RR Tires & Black Wheels, 1/18 Asphalt Modified (4)
1RC2048	Frame, 1/18 Asphalt Modified	1RC6058	Body Set, Clear, 1/18 Asphalt Modified
1RC2050	Nerf Bars, 1/18 Asphalt Modified	1RC7000	8700kv Brushless Motor & 12T Pinion, 1/18 Spr, EDM
1RC2051	Headers, 1/18 Asphalt Modified	1RC7007	NiMH Battery, 5 Cell NiMh, 6.0V, 220mAH, 1/18 Mid, Spr,
1RC2057	Front Bumper, 1/18 Asphalt Modified	1RC7009	Heatsink, Motor, 1/18 Mid, Spr, EDM
1RC3000	Rear End, 1/18 Mid, Spr, EDM	1RC7012	Transmitter & Receiver, GT2E
1RC3020	Front Suspension Plastics Set, 1/18 LM	1RC7014	ESC Only, 1/18 Scale
1RC3021	Front Suspension Hardware Set, 1/18 LM	1RC7020	Steering Servo, 1/18 LM
1RC3023	Front Spindles, 1/18 LM	1RC8000	Hardware Set, 1/18 Mid, Spr, EDM
1RC3027	Radius Rods, 1/18 Asphalt Modified	1RC8001	Ball Stud & Pivot Ball Set, 1/18 Mid, Spr, EDM
1RC4000	Rear Axle & Compound Gear, 1/18 Mid, AM	1RC8002	Roll Pin Set, 1/18 Mid, Spr, EDM (8)
1RC5000	Shock Set, 1/18 Mid, Spr, EDM (4)	1RC8503	Bearing Set, 1/18 Mid, Spr, EDM (8)
1RC5001	Spring Kit, 1/18 Mid, Spr, EDM		

Option Parts

1RC2049	Frame Sides Only, 1/18 Asphalt Modified	1RC5007	Threaded Alum Shock Body Set, Blue
1RC3013	Rear End, Black, 1/18 Mid, Spr, EDM	1RC5008	Short Spring Set, 1/18 Mid, Spr, EDM, LM (12)
1RC3025	Servo Arm, Solid, 21T, 1/18 LM	1RC5550	FR/RR Tires & Chrome Wheels, 1/18 Asphalt Modified (4)
1RC3028	Radius Rods, Black, 1/18 Asphalt Modified	1RC5551	FR/RR Soft Tires & Black Wheels, 1/18 Asphalt Modified (4)
1RC4003	Offset Wheel Hexes, 1/18 Mid, Spr, EDM	1RC5552	FR/RR Soft Tires & Chrome Wheels, 1/18 Asphalt Modified (4)
1RC5006	Threaded Alum Shock Body Set, Silver	1RC7017	Steering Servo, Digital Metal Gear, 18th Scale

Visit our website at www.1rc-racing.com to see more details.

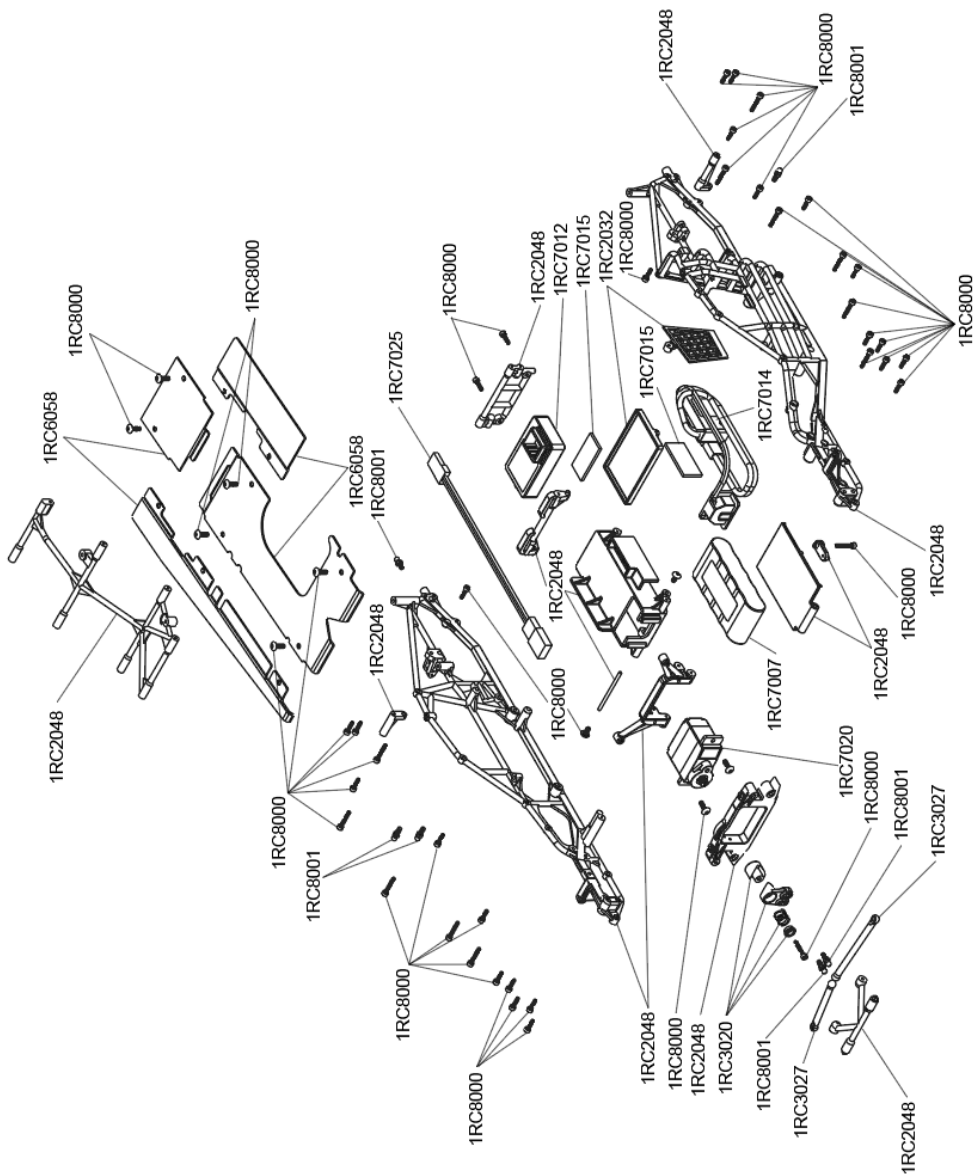

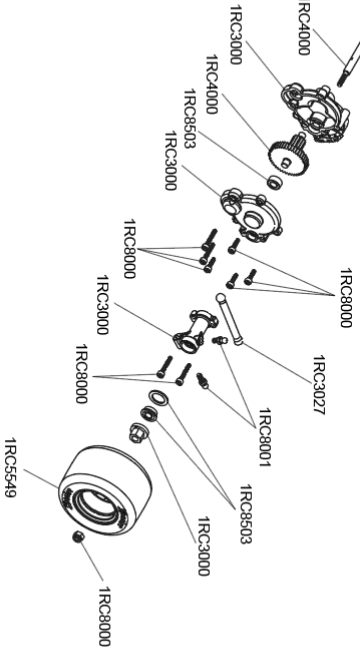
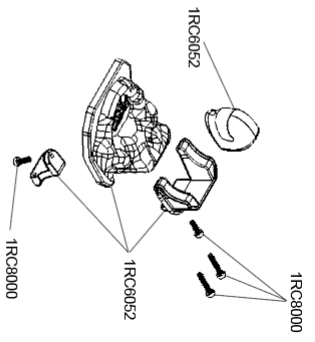
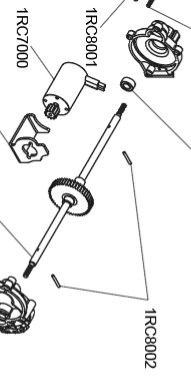
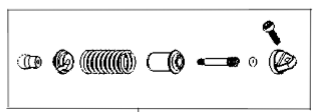
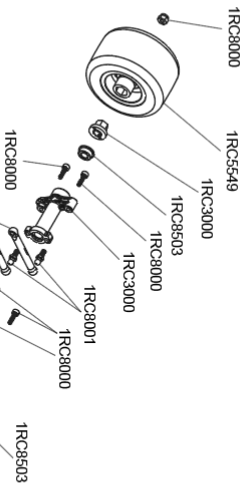
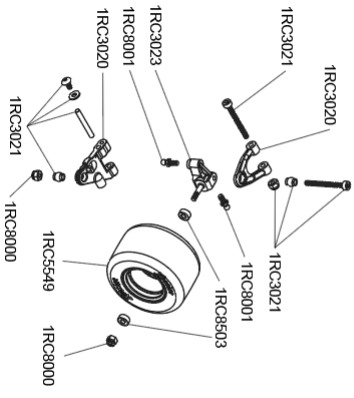

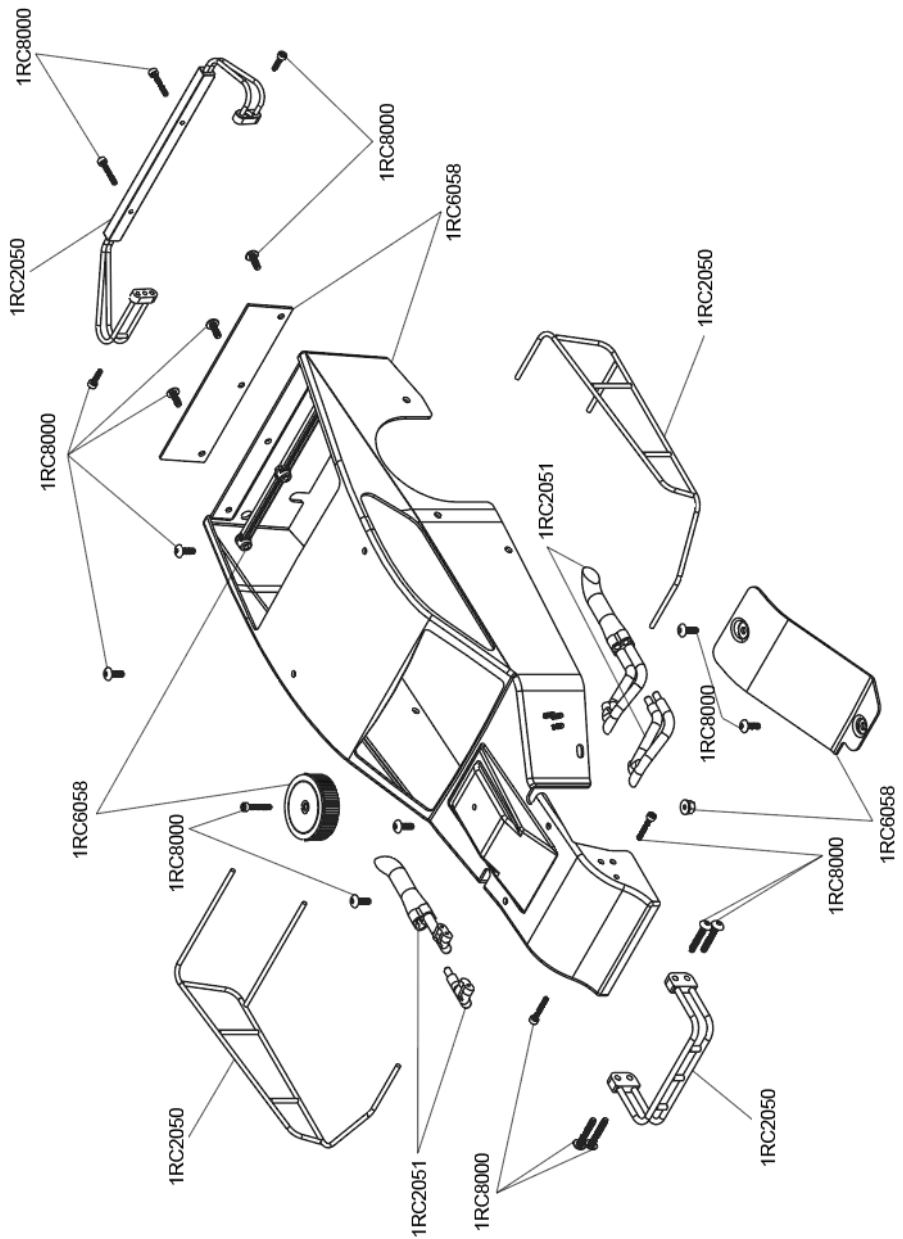

Set-Up Tips

Not Enough Steering on Corner Entry	Turn up dual rate on radio
	Less tension on right front spring
To Much Steering on Corner Entry	Turn down dual rate on radio
	More tension on right front spring
Not Enough Steering on Corner Exit	Turn up dual rate on radio
	More tension on right rear spring
To Much Steering on Corner Exit	Turn down dual rate on radio
	Less tension on right rear spring

Notes

Limited Warranty and Service Contact Information

Limited Warranty

1 RC Racing, LLC warrants the model and its components to be free of defects in material and workmanship at the date of purchase to the original purchaser, warranty is not transferable.

Limitation of Liability

1 RC RACING, LLC SHALL NOT BE LIABLE FOR SPECIAL, INDIRECT, INCIDENTAL OR CONSEQUENTIAL DAMAGES, LOSS OF PROFITS OR PRODUCTION OR COMMERCIAL LOSS IN ANY WAY, REGARDLESS OF WHETHER SUCH CLAIM IS BASED IN CONTRACT, WARRANTY, TORT, NEGLIGENCE, STRICT LIABILITY OR ANY OTHER THEORY OF LIABILITY, EVEN IF 1 RC RACING, LLC HAS BEEN ADVISED OF THE POSSIBILITY OF SUCH DAMAGES.

Service Contact Information

All service/warranty requests should be sent to support@1RC-Racing.com and should contain the following information.

1. Name and shipping address and contact info
2. Picture of part(s) in question
3. Description of running condition when part broke

All warranties will be reviewed and an email will be sent back within 2-5 days with details of the warranty.

Regulation Statements



FCC Compliance

This device complies with part 15 of the FCC rules. Operation is subject to the following two conditions: (1) This device may not cause harmful interference, and (2) this device must accept any interference received, including interference that may cause undesired operation.

The user is cautioned that changes or modifications not expressly approved by the party responsible for compliance could void the user's authority to operate the equipment.

FCC ID: N4ZFLYSKYGT2E



Battery Recycling (USA)

Product must not be disposed with other waste. Call 1-800-228-8379 for information on battery recycling in your area.



IC INFORMATION

IC: 25584-GT2E0 HVIN: Transmitter: FS-GT2E Receiver :FS-A3

This device complies with Industry Canada license exempt RSS standards. Operation is subject to the following two conditions: (1) This device may not cause interference, and (2) this device must accept any interference received, including interference that may cause undesired operation of the device.

Le présent appareil est conforme aux CNR d'Industrie Canada applicables aux appareils radio exempts de licence. L'exploitation est autorisée aux deux conditions suivantes: (1) L'appareil ne doit pas produire de brouillage, et (2) L'utilisateur de l'appareil doit accepter tout brouillage radioélectrique subi, même si le brouillage est susceptible d'en compromettre le fonctionnement.



1 RC Racing, LLC

www.1RC-Racing.com

support@1RC-Racing.com