



SUPER PNP
Instruction Manual



ATTENTION

BEFORE CONTINUING WITH THIS INSTRUCTION MANUAL OR ASSEMBLY OF YOUR MAMBA 10, PLEASE VISIT OUR WIKI SUPPORT SITE FOR THE LATEST PRODUCT UPDATES , FEATURE CHANGES, MANUAL ADDENDUMS AND FIRMWARE CHANGES FOR BOTH YOUR MAMBA 10 AND THE INSTALLED AURA 8 ADVANCED FLIGHT CONTROL SYSTEM.

<http://wiki.flexinnovations.com/wiki/Mamba10>
<http://wiki.flexinnovations.com/wiki/Aura>

TABLE OF CONTENTS

Introduction	2	Connecting Battery/Arming ESC	9
Box Contents	2	Main Wing Installation.....	10
Specifications.....	3	Control Direction Test.....	12
Replacement Parts Listing.....	3	Flight Control Direction Sensing Test.....	13
Optional Completion Items.....	3	Linkage Setup.....	14
Completion Items	3	Propeller/Spinner Installation.....	14
Battery Charging Guidelines.....	3	Battery Installation.....	15
Special Language Definitions.....	4	Center of Gravity.....	15
Important Information Regarding Warranty.....	4	Flying your Mamba 10.....	16
Safety Warnings and Precautions.....	4	Advanced Mamba 10 Setup.....	17
Low Voltage.....	4	Airframe Repairs	18
Main Landing Gear Installation.....	5	Replacing Servos.....	18
Tailwheel Installation.....	5	Servicing the Power System.....	19
Horizontal Stabilizer Installation.....	6	Optional Wheelpant Removal	19
Transmitter Setup.....	7	Aircraft Troubleshooting Guide.....	20
Aura 8 ACFS.....	7	Limited Warranty.....	21
Receiver Installation/Servo Connections.....	8	AMA Safety Code.....	22

INTRODUCTION

Biplanes offer a unique challenge as every aspect of the design must be optimized, from the structure, to the aerodynamics, and control system.

Only years of experience designing aircraft in this category can produce the Mamba 10's aggressive, yet forgiving characteristics. Designer Quique Somenzini knows how to optimize biplane aerodynamics like no other, having won F3A and 3D world championships with his biplane designs. A biplane with less coupling or better manners cannot be found. The structure is highly optimized offering an aircraft that is stiff and strong, yet light in weight.

Couple a phenomenal airframe with the Aura 8 Advanced Flight Control System, the latest in stabilization technology, and you get an incredible performance package; one that remains stable, yet maneuverable. Pilots rave about its direct and non-interfering feeling, and its ability to bring out the best in aircraft.

- Available in red/silver and green/silver schemes
- Advanced Aura 8 Control System
- **SIX** Servos included! **FOUR** for Ailerons
- Innovative plywood sub-frame connects the motor securely to the fuselage while providing superior battery mounting and cooling
- **Extreme** 3D Performance
- Light wing loading for easy handling
- Large control surfaces for excellent maneuverability
- Factory-installed Shark Teeth for low speed control
- Precise aerobatics with minimal control coupling
- Easy disassembly for transport in small cars

BOX CONTENTS

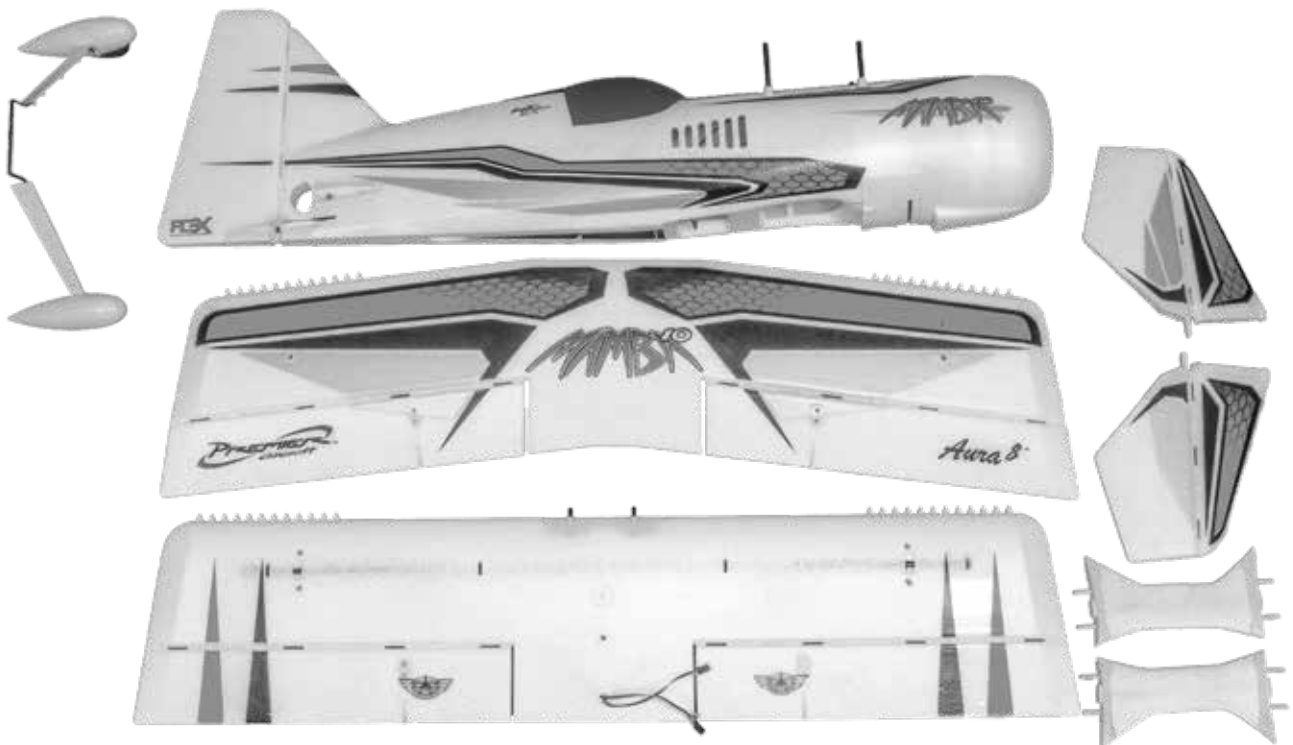

SPECIFICATIONS

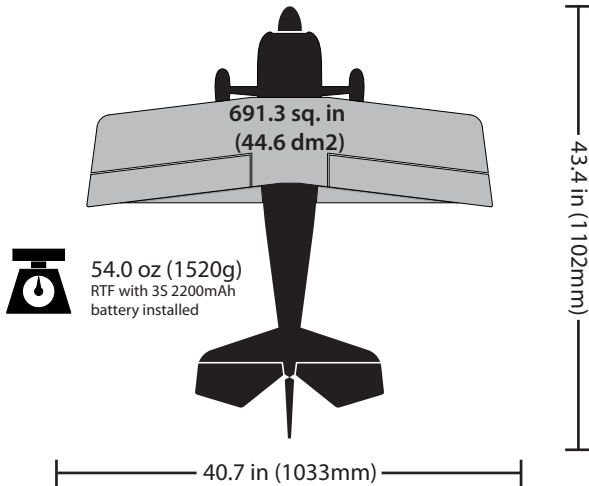

REPLACEMENT PARTS LISTING

FPM3270A	Mamba 10 Super PNP Green
FPM3270B	Mamba 10 Super PNP Red
FPM327001	Mamba 10 Fuselage
FPM327002	Mamba 10 Wing Set w/Struts
FPM327003	Mamba 10 Tail set
FPM327004	Mamba 10 Hatch set
FPM327005	Mamba 10 Landing gear set
FPM327006	Mamba 10 Stab Tube Joiner Cabane Tube Set
FPM327007	Mamba 10 Pushrod set
FPM327008	Mamba 10 Green/Blue Decal Set
FPM327009	Mamba 10 Red/Black Decal set
FPM327010	Mamba 10 Spinner 50mm
FPM327011	Mamba 10 Hardware Package
FPZM1010C	Potenza 10 1400 Kv BL Motor
HW-BQ8015	Hobby Wing 50A Skywalker 5A BEC
FPZDS15	Potenza DS15 Digital Sub-Micro Servo
FPZA1015	Servo Custom Y-Harness (Mamba 10)
FPZAURA08ZZM10	Aura 8 for Mamba 10

OPTIONAL COMPLETION ITEMS

FPZM1010D	Potenza 10 1070 Kv BL Motor (For 4S LiPo Battery Only)
FPZB22004S40	Potenza 2200mAh 4S 14.8v 40C LiPo
FPZC80	C80 Multi-Chemistry Touch Screen AC/DC Smart Charger
FTVHQBQ2006	Hobbywing ESC Programming Card
FPZA1010	Potenza Digital Battery Analyzer
FPZAU01	Male to Male Servo Connectors (3)
FPZ327012	Mamba 10 4CH Aileron Servo Ext. Kit
FPMTT2	TruTurn 2-in Aluminum Spinner
LP12045MR	APC 12x4.5MR Propeller (For 4S LiPo Battery Only)

COMPLETION ITEMS

INSTALLED!		Potenza 10 1400 Kv Brushless Outrunner Motor (FPZM1010C)
INSTALLED!		HobbyWing SkyWalker 50A ESC with 5V/5A SBEC (FTVHQBQ8015)
INSTALLED!		Potenza DS15 Digital Full Metal Gear 15g Servo (FPZDS15)
INSTALLED!		Aura 8 Advanced Flight Control System (FPZAURA08)
INCLUDED!		SR 11.5x4.5 Thin Electric Propeller (FPMP11545E)
NEEDED TO COMPLETE		2200mAh 3S 11.1v 45C LiPo (FPZB22003S45) 3S 11.1v 2100-3300mAh minimum 45C+ LiPo
NEEDED TO COMPLETE		6-Channel Computer Transmitter*
NEEDED TO COMPLETE		DSM2/DSMX remote receiver(s) SRXL/S.Bus Futaba/Graupner HOTT/ JR XBus/Jeti UDI 5+ Channel RX (any brand)

*DX4/5e class transmitter supported with special model program download

BATTERY CHARGING GUIDELINES

WARNING

FOLLOW ALL INSTRUCTIONS PROVIDED BY YOUR BATTERY AND CHARGER MANUFACTURER. FAILURE TO COMPLY CAN RESULT IN FIRE.

The assembly of the Mamba 10 can be accomplished in less than **one hour**. Prior to assembling the airplane, it is advisable to charge your battery so that you are ready to begin setup upon completion of the assembly of your model.

We recommend the use of an advanced LiPo balancing charger, such as our Potenza C80 Multi Chemistry Touch Screen AC/DC balancing charger for your batteries to get the maximum performance and lifespan from them.

Our airplanes are designed around our Potenza LiPo batteries and we recommend the Potenza 3S 2200mAh 45C LiPo and the 4S 2200mAh 40C LiPo in the Mamba 10 based on our extensive testing and development. This battery features an EC3 connector, so no soldering is required for use in your Mamba.

All are available online at www.flexinnovations.com and your local Flex Innovations retailer.

SPECIAL LANGUAGE DEFINITIONS

The following terms are used throughout the product literature to indicate various levels of potential harm when operating this product:

- NOTICE:** Procedures, which if not properly followed, create a possibility of physical property damage AND a little or no possibility of injury.
- CAUTION:** Procedures, which if not properly followed, create the probability of physical property damage AND a possibility of serious injury.
- WARNING:** Procedures, which if not properly followed, create the probability of property damage, collateral damage, and serious injury OR create a high probability of serious injury.

WARNING

AGES 14+

This product is not intended for use by children under 14 years without direct adult supervision.

ATTENTION

Read the ENTIRE instruction manual to become familiar with the features of the product before operating. Failure to assemble or operate the product correctly can result in damage to the product, personal property, and cause serious or fatal injury.

All instructions, warranties and other collateral documents are subject to change at the sole discretion of Flex Innovations, Inc. For up-to-date product literature, please visit our website at www.flexinnovations.com and click on the Mamba 10 and Aura 8 product pages.

IMPORTANT INFORMATION REGARDING WARRANTY

Please read our Warranty and Liability Limitations section before building this product. If you as the Purchaser or user are not prepared to accept the liability associated with the use of this Product, you are advised to return this Product immediately in new and unused condition to the place of purchase.

SAFETY WARNINGS AND PRECAUTIONS

Protect yourself and others by following these basic safety guidelines.

1. This manual contains instructions for safety, operation and maintenance. It is essential to read and follow all the instructions and warnings in the manual, prior to assembly, setup or use, in order to operate correctly and avoid damage or serious injury.
2. This model is not a toy, rather it is a sophisticated hobby product and must be operated with caution and common sense. This product requires some basic mechanical ability. Failure to operate this product in a safe and responsible manner could result in injury or damage to the product or other property.
3. This model must be assembled according to these instructions. Do not alter or modify the model outside of these instructions provided by Flex Innovations, Inc, as doing so may render it unsafe and/or unflyable. It is your responsibility to ensure the airworthiness of the model.
4. Inspect and check operation of the model and all its components before every flight.
5. If you are not an experienced pilot or have not flown a high-performance model before, it is recommended that you seek assistance from an experienced pilot in your R/C club for your first flights. If you're not a member of a club, the Academy of Model Aeronautics (AMA) has information about clubs in your area whose membership includes experienced pilots.
6. Keep the propeller area clear from such items such as loose clothing, jewelry, long hair, or tools as they can become entangled. Keep your hands and body parts away from the propeller as injury can occur.
7. Never fly in visible moisture or submerge the airplane or any of its electronic components in water. Permanent damage to electronic components may occur, or corrosion of components may lead to intermittent failures.

LOW VOLTAGE CUTOFF

LiPo batteries have a nominal (rated) voltage of 3.7v per cell, and fully charged, reach 4.2v per cell. Batteries are designed to be discharged below the nominal voltage, however, if they are discharged below 3.0v per cell, damage will occur and the pack will lose capacity. For best long term battery life, set a timer and land after a time that leaves approximately 15% of the battery's capacity remaining.

Low voltage cutoff is a feature that is built into the Hobby Wing SkyWalker 50A ESC that is designed to protect the connected battery from being discharged too far and causing permanent damage to the cells. Circuitry within the ESC will automatically detect when the input voltage from the battery pack reaches below 3.15v per cell (average) and will remove power to the motor, but still deliver power to the servos so that a safe landing may be made. If the motor begins to lose power rapidly during flight, the LVC has sensed that the total voltage of the pack has dropped below 3.15v per cell average, and the airplane should be landed immediately.

MAIN LANDING GEAR INSTALLATION



Required Tools and Fasteners: #1 Phillips Screwdriver, (4) M3x12 self-tapping Phillips head cap screws

1. Insert the landing gear assembly into the slot in the bottom of the fuselage. The gear will sweep forward.
2. Install the cover plate over the landing gear slot and attach with (4) M3x12 self-tapping Phillips head cap screws.



TAILWHEEL INSTALLATION

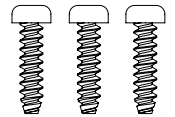

Required Tools and Fasteners: #1 Phillips Screwdriver, (3) M3x12 self-tapping Phillips head cap screws

1. Insert the tailwheel assembly in the slot in the bottom of the rudder.
2. Install the cover plate over the tailwheel slot and attach with (3) M3x12 self-tapping Phillips head cap screws.



HORIZONTAL STABILIZER INSTALLATION

Required Tools and Fasteners: Clear Tape (4 strips)

1. Insert the horizontal stabilizer tube into the fuselage and roughly center.
2. Slide the left and right stabilizer halves onto the tube. Ensure that the control horn orients towards the belly of the airplane and that the elevator joiner tabs are properly indexed. **Do not force the stabilizer into place.**
3. Apply 4 pieces of clear tape to the joint between the stabilizer and the plastic mounts. Be sure to apply tape to both the top and bottom.
4. Attach the clevis to the elevator control horn in the innermost hole. Slide the clear tubing over the forks.





WARNING

DO NOT ATTEMPT RADIO SETUP WITH PROPELLER INSTALLED. INADVERTENT POWER UP COULD CAUSE PERSONAL INJURY.

TRANSMITTER SETUP

Start with a freshly reset new model memory in your transmitter. Make ONLY the changes shown in the Transmitter Setup Guide.

The Aura 8 in the Mamba 10 defaults to 3 flight modes that are switched via CH5/Gear in your transmitter. You may need to reassign CH5/Gear to a 3-position switch. Consult your transmitter manufacturer for directions on channel assignment.

For large (greater than 5%) changes in expo or dual rates, it is highly recommended to reset all expos and rates to default in the transmitter and tune through the Aura Config Tool.

The Aura Config Tool can be used on any Windows-based PC or tablet. Download at www.flexinnovations.com/AuraConfigTool.

TRANSMITTER CONFIGURATION GUIDE

Wing Type	Normal - 1 Aileron, 1 Elevator, 1 Rudder	
End Points ¹	Aileron ² /Elevator/Rudder	125%
	Throttle/CH5 (Gear)	100%
Sub Trim	Verified neutral, sub trim not allowed	
Trim Levers	Verified neutral	
CH 5 (Gear)	Assigned to a 3-position switch	
Reversing	Aileron/Elevator/Rudder Normal ³	
Timer	Set to 3:30 for initial flights ⁴	

¹ JR Mode B users should set throttle/aileron/elevator/rudder/gear travel values to **88%**

² It is recommended that for pilots with less experience, set up a transmitter dual rate of 75% for the aileron channel only if using end points of 125%. The ailerons of the Mamba 10 are very responsive and produce a very high roll rate. **125% end point should be reserved for advanced pilots ONLY.**

³ Throttle direction depends on transmitter manufacturer, but leave at transmitter default setting

⁴ The Mamba 10 can fly anywhere between 3:30 to 5:30 depending on flying style

AURA 8 ACFS

The Aura 8 advanced flight control system installed in your Mamba 10 is a giant leap forward in aircraft flight control system technology. Compatible with virtually every receiver on the market today, the Aura features special configuration for DSM systems via remote receiver connection(s), and serial data connection for Futaba S.Bus, Spektrum SRXL Graupner HOTT (Sum D of 8), JR XBus (Mode B), and Jeti UDI12 (standard) systems, as well as being compatible with traditional receivers via PWM servo connections.

The Aura 8 advanced flight control system in your Mamba 10 has been pre-tuned for ease of use, eliminating many hours of tedious setup. For the latest Aura Features, programs, transmitter downloads, and instructions, please visit wiki.flexinnovations.com/wiki/Aura.

The Aura is fully customizable through any Windows-based PC or tablet. All dual rate, expo, travel, and assignable mode programs are adjusted inside the Aura through the PC application. An assignable master gain that is **OFF** by default can be enabled by the Aura application. If desired, assign CH 8/AUX 3 on a proportional dial or slider.

By default CH5/Gear is used to select the 3 flight modes by 3 position transmitter switch.

- Works conveniently with all major radio systems
- Accepts signals from PPM Stream, Futaba S.Bus, DSM remote receiver(s), Spektrum SRXL, Graupner Hott (Sum D of 8), JR XBus (Mode B), Jeti UDI12 (standard), or any brand of receiver via male to male servo connectors
- Expertly tuned and ready to use
- USB port allows loading model configurations, user programming, and firmware updates (cable included)
- Flexible and extensive programming through Windows-based PC or tablet Aura Config Tool app
- 3+ flight modes allow precise or aggressive settings to be selected in flight
- 3-axis gyro utilized in Mamba 10 programming
- Powerful 32-bit processor and 6 axis sensor for future updates and re-use

Visit <http://wiki.flexinnovations.com/wiki/aura> for the latest Aura-related product information.

Description of Pre-Loaded Aura Flight Modes

Mode 1 (Gyro Off): Rates are set for general flight (same as Sport Mode). Exponential is tuned for comfortable flight.

Mode 2 (Sport Mode): Gains are moderate and tuned for comfortable feel/best performance for precision aerobatics. Expo is tuned for comfortable flight.

Mode 3 (3D Mode): Gains are highest and tuned for 3D aerobatics. Rate are set to highest. Exponential is tuned for comfortable flight.

NOTE- Rudder stick movement will also move ailerons and elevator. This is NORMAL and is the pre-programmed mixing.

Each of the modes has been tuned by our team to offer a solid start. Because tastes in control feel are unique, if changes in rate and expo are needed adjustments should be made through Aura. Changes on gain value may only be made through the Aura.

AURA CONFIGURATION REFERENCE

		Mode 1	Mode 2	Mode 3
#Aura 8 Rate Setup	Aileron	▲▼ 40%	▲▼ 40%	▲▼ 100%
	Elevator	▲▼ 22%	▲▼ 22%	▲▼ 100%
	Rudder	◀▶ 70%	◀▶ 90%	◀▶ 90%
		Mode 1	Mode 2	Mode 3
#Aura 8 Expo Setup	Aileron	▲▼ 30%	▲▼ 20%	▲▼ 32%
	Elevator	▲▼ 25%	▲▼ 10%	▲▼ 40%
	Rudder	◀▶ 30%	◀▶ 30%	◀▶ 20%

The shown Aura 8 settings are pre-configured and the unit is ready to use. The chart shown is for information purposes only. **Do not program these rates and expos in to your transmitter.** No additional action is required to fly the airplane.

RECEIVER INSTALLATION/SERVO CONNECTIONS

Aura will auto-detect modern digital receiver connection. Using a modern digital receiver connection gives the Aura access to precise data of each channel for additional gyro enabled outputs, simplifies wiring, and allows for more advanced features. To connect a modern digital receiver connection, follow the steps on this page, then skip ahead to the control direction test on page 12.

For traditional PWM receivers without digital connection, male to male servo leads must be used for each channel. Please refer to the connection diagram on page 9.

Supported Modern Digital Receiver Connections

Aura will detect these modern digital receiver connections:

Spektrum Remote Receiver(s)	Spektrum SRXL
Futaba S.Bus	JR XBus (Mode B)
Graupner HOTT (Sum D of 8)	Jeti UD12 (standard)*

A PPM (8CH, negative shift, approximately 22ms/frame) receiver may also be connected into Port 'B'; however Aura will not auto-detect and setup must be performed through the Aura Config Tool (Windows Application)

Connecting Your Receiver to Aura

Spektrum Remote Receivers

1. Connect (1) Spektrum remote receiver to Mini Port 'A' at the top of the Aura case.
2. To bind a DSMX Spektrum Remote Receiver connection, insert a bind plug into Aura Port S8.

To bind a DSM2 Spektrum Remote Receiver connection, insert a bind plug into Aura port S1 AND S8.

If you are unsure which type of DSM remote receiver you have, start by attempting the bind process with the bind plug in S8. If you continue to have trouble binding, then insert a bind plug into S1 AND S8

Connect the flight battery to the ESC, and the remote receivers should begin to flash, indicating they are ready to bind. Bind from here as recommended in your transmitter manufacturer's direction.

3. Once bound (indicated by each remote receiver showing a solid orange LED), Aura will begin the Auto-Detect process, searching for a valid control signal, indicated by sweeping LEDs on the Aura. Once found, you will see solid orange (power and calibrated sensor) and solid green (valid receiver data) LEDs, indicating the Aura is in its flight-ready state.
4. Mount your receivers using double sided foam tape, or hook and loop tape. Consult your receiver manual for proper mounting orientations.

All Other Digital Receiver Connections

1. While Spektrum and Futaba typically output their digital data stream, it may be necessary for JR DMSS, Graupner HoTT and Jeti users consult your radio documentation and program the transmitter/receiver to output the correct digital data format as listed above.
2. Bind your transmitter and receiver per your manufacturer's instructions.
3. Connect the included male to male extension to the receiver's data port (ex: S.Bus) and connect to servo port 'B' on the face of the Aura. Refer to your radio manufacturer's instructions for specific information on appropriate serial port connections and system settings.

With the transmitter powered, power up the aircraft. Aura will search (sweeping LEDs) and lock onto the signal. You will then see solid orange (power and calibrated sensor) plus solid green (valid radio source), and have control of the model.

4. Mount your receiver using double sided foam tape or hook and loop tape. Consult your receiver manual for proper mounting and antenna placement.

DEFAULT AURA CONNECTIONS

- S1 Throttle (ESC/BEC)
- S2 Left Aileron
- S3 Right Aileron
- S4 Elevator
- S5 Rudder

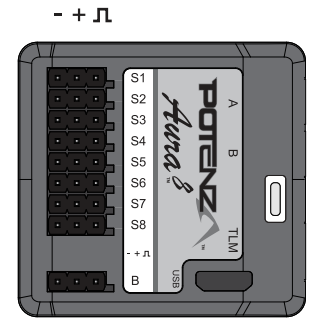

Jeti/UDI users, for more information, please visit <http://wiki.flexinnovations.com/wiki/Aura/JetiUse>
 FrSky Taranis users, for more information, please visit <http://wiki.flexinnovations.com/wiki/Mamba10>
 Graupner users, for more information, please visit <http://wiki.flexinnovations.com/wiki/Aura/GraupnerHoTTUse>

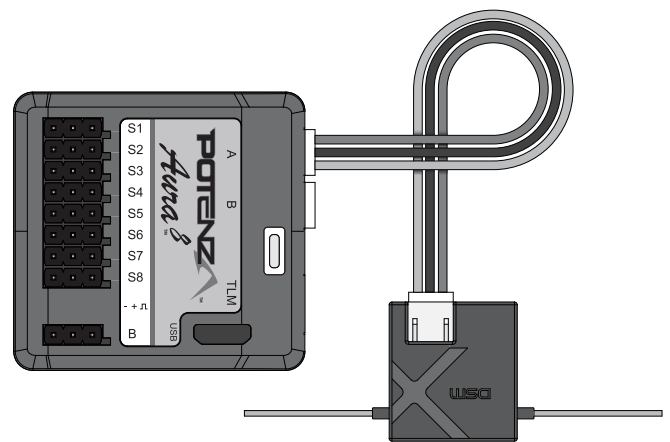

NOTE: It may be necessary to move the ESC lead to another open port (such as port 'B') during the binding procedure. Be sure to return the ESC lead back to S1 after binding is complete

NOTE: There are many JR-branded remote receivers that use Spektrum DSM2 and DSMX RF Protocol. For these, follow the instructions as a Spektrum remote receiver.

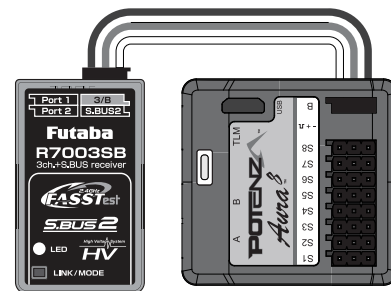

NOTE: When using S.Bus, Aura reverses throttle direction. It is therefore NOT necessary for Futaba S.Bus users to reverse throttle IF the throttle/ESC is left plugged into Aura.

RECEIVER INSTALLATION/SERVO CONNECTIONS (CONTINUED)

Connecting a traditional receiver to Aura with PWM Servo Connections

PWM is an acronym which stands for Pulse Width Modulation. A servo will move to a specific angle in a specific direction based on the width of the signal pulse it receives. Most transmitters output a total pulse width of 1.1-1.9ms, with the midpoint being 1.5ms. Lower pulse widths will move the servo to one side of neutral and higher pulse widths to the other side of neutral. In order to utilize this type of receiver connection with your Mamba 10, male to male servo leads to connect the corresponding receiver ports to Aura are required. A minimum 6-channel receiver is required to setup Aura with PWM connections. Please purchase **FPZAU01 Aura 3-piece male to male servo cable/S.Bus** to complete the PWM connection setup.

1. Bind your receiver to your transmitter by following the instructions provided by your transmitter and receiver manufacturer. Verify that it is bound by connecting a spare servo to the receiver and verify that it responds to the appropriate input.
2. With the transmitter and receiver powered **OFF**, connect your receiver to Aura using the diagram below. Note that the throttle is plugged directly into the receiver.

! NOTICE

VERIFY PROPER POLARITY OF ALL CABLE CONNECTIONS PRIOR TO ADDING POWER TO THE SYSTEM

All four (4) PWM male-to-male connections must be connected AND connected in the proper polarity from receiver outputs to Aura inputs for Aura to activate servo outputs. (Aileron - S1, Elevator - S2, Rudder - S3, Gear/CH5 - S4)

3. With the propeller removed and ALL connections made between Aura and the receiver (observing correct polarity), power on your transmitter and the airplane with the flight battery, ensuring that the airplane is kept stationary. After a few seconds, the LEDs on Aura will sweep back and forth as Aura searches for a valid control signal. Once found, a solid orange (Aura running) and solid green (Aura receiving valid signal from the receiver) LED is illuminated. **After the source is found, apply transmitter right rudder to assist Aura determine your radio type**, after which point control of the model is established. This is only required during initial setup.

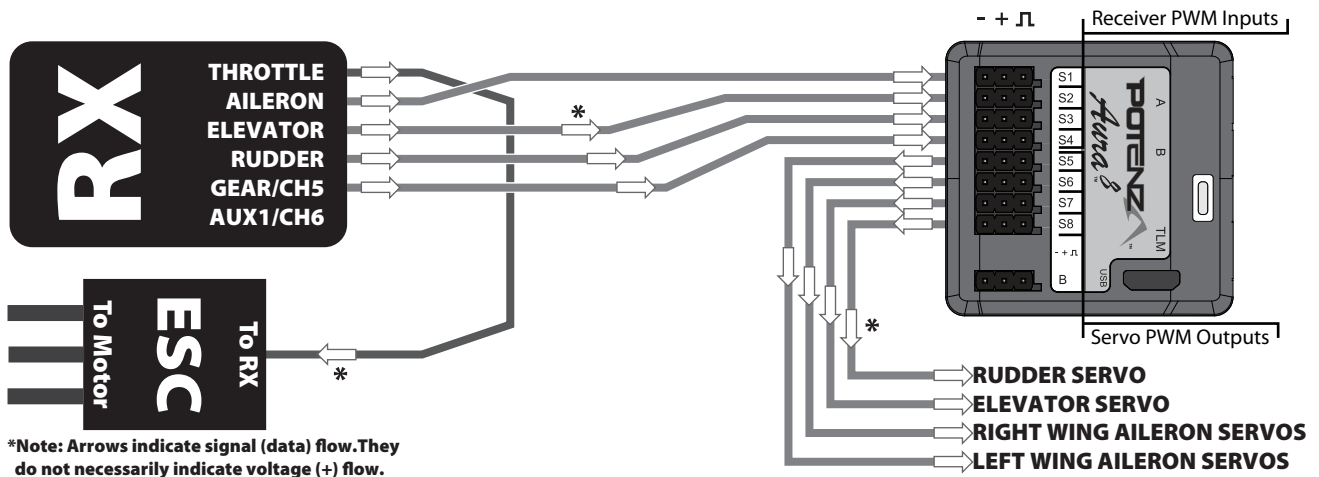

CONNECTING BATTERY/ARMING ESC

Observe the following procedures to safely power up your model after it has been bound. **Ensure propeller is removed unless sequence is followed to power up before flight.**

1. Lower the throttle stick and trim to their lowest setting and turn on the transmitter. Wait for your transmitter to indicate the RF signal is being broadcast before proceeding.

If a battery is connected to the ESC with the throttle fully open on the active transmitter, the ESC will enter into programming mode. If this occurs, simply disconnect the battery, lower the throttle, and reconnect the battery.

2. Ensure the rudder, elevator, and aileron gimbals are centered.
3. With the airplane on a solid surface; connect the battery to the ESC and wait. The ESC will emit a series of audible tones during its initialization process.
4. The ESC will emit a short, final tone sequence indicating that the ESC is now armed, and that the motor will spin in response to throttle stick movement.

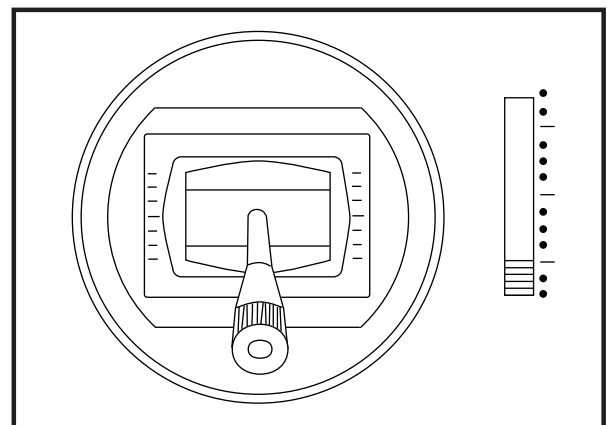

! CAUTION

Always connect the battery when the throttle stick and throttle trim are in the idle/cut-off position.

! WARNING

When making adjustments to linkages, transmitter settings, or the Aura 8 flight control system, remove the propeller to guard against accidental spool up.

! WARNING

Hold aircraft securely when connecting the battery before flight. Always ensure that the propeller is clear of any and all objects as they may become entangled.

MAIN WING INSTALLATION



Required Tools and Fasteners: #1 Phillips Screwdriver, (4) M2x6mm self-tapping Phillips head screws,
(1) M3x70mm Phillips machine screws, (8) M3x12mm self-tapping Phillips head screws

1. Locate the (4) cabane struts, fuselage, and top wing. Dry fit the cabane struts into the moulded mounts in the wing and fuselage to ensure proper fitment and alignment. The longer rods are the rear cabane struts, the shorter rods are the front cabane struts.
2. Rotate the cabane to align the screw holes in the cabane and cabane mount and secure to the upper mounts in the top wing with (4) M2x6mm screws. Insert the interplane struts in the lower mounts on the fuselage and mark the depth that each strut inserts into the mount.
3. Remove the wing and wrap low-tack masking tape around the strut on the line marked in Step 2. Using medium (150) grit sandpaper, roughen the lower portion of each cabane strut. Remove tape and clean struts and inside of the fuselage mounts with isopropyl alcohol.
4. Glue cabane struts into the lower mounts on the fuselage with 15-minute epoxy. **FULLY SEAT CABANE STRUTS INTO THE LOWER MOUNTS ON THE FUSELAGE AND ENSURE THEY REMAIN SEATED.** Clean excess epoxy prior to curing.
5. Once the epoxy has fully cured, unscrew the top wing from the cabane struts and temporarily place it to the side.
6. Locate the bottom wing and the (2) interplane struts.



MAIN WING INSTALLATION (CONTINUED)

7. Attach the interplane struts to the bottom wing using (4) M3x12mm Phillips head cap screws. While the struts are directional and will only fit one way, ensure that the logo is oriented outwards and on the bottom side of the strut, oriented upright.
8. Connect the aileron servo leads to either y-harness. Be sure to connect the left wing servo to the lead labeled **AIL L**, and right wing servo to the lead labeled **AIL R**, then gently guide them inside the fuselage while mating the bottom wing to the fuselage.
9. Attach the bottom wing to the fuselage with (1) M3x70mm Phillips screws.
10. Re-attach the top wing to the cabanes using the (4) M2x6mm Phillips self-tapping screws removed in Step 5.
11. Attach the top wing to the interplane struts using (4) M3x12mm Phillips self-tapping screws.

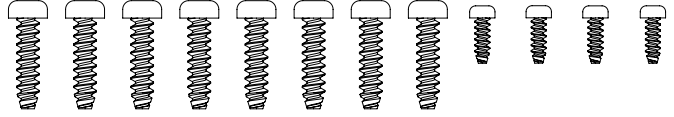







CONTROL DIRECTION TEST

Refer to the chart below to determine the proper control surface directions.

If controls are reversed, DO NOT REVERSE CONTROLS IN TRANSMITTER OR IN THE AURA CONFIG TOOL. Email us at support@flexinnovations.com for corrective action. Note that BOTH the Transmitter Control Direction Test AND the Flight Controller Sensor Direction Test MUST BOTH BE PASSED! IF ONE DOES NOT PASS, DO NOT FLY!











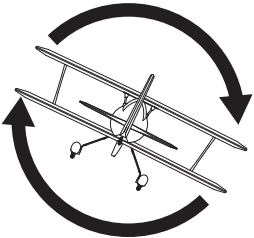

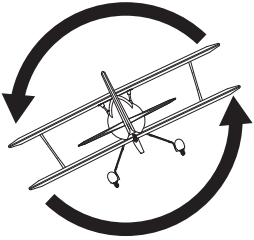
NOTE: There is pre-configured rudder to aileron and rudder to elevator mixing programmed into the Aura. Simultaneous movement of these control surfaces with rudder input is intentional and completely **NORMAL**.

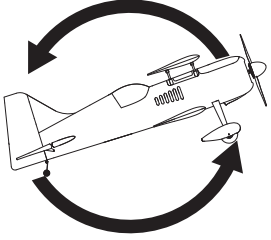
	Transmitter Command	Proper Control Surface Deflection
AILERON	Stick Left	
	Stick Right	
ELEVATOR	Stick Forward	
	Stick Aft	
RUDDER	Stick Left	
	Stick Right	

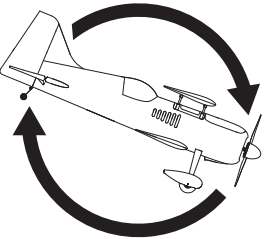
FLIGHT CONTROL SENSING DIRECTION TEST

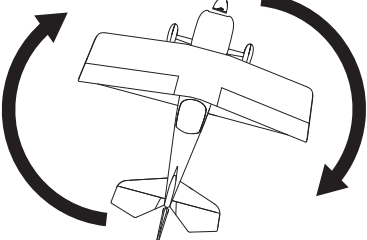
Perform a test of the gyro system to verify the corrections made for a given movement are correct. If any of the tests do not result in the correct reaction from the airplane's gyro system, **DO NOT FLY THE AIRPLANE**, and contact us via email at support@flexinnovations.com

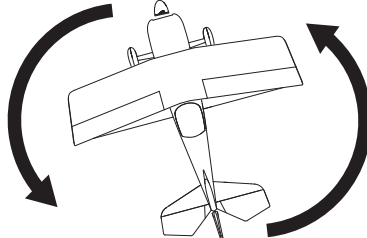
The flight control system activates with RF broadcast. Perform these tests in Mode 3 (higher gain) for better visibility and then in Mode 2, and any other modes that have gyro gains assigned. (By default, Mode 1 has no gain assigned.). Control surface deflections are exaggerated in the drawings below for clarity. Please note that the control surfaces will move **ONLY** when the aircraft is being **ROTATED**.

	Aircraft Movement	Proper Control Surface Deflection
AILERON		
		
ELEVATOR		
		
RUDDER		
		

LINKAGE SETUP

Adjust the control linkages so that the surfaces are neutral with zero trim and zero subtrim. Adjustments may be required during flight trimming – for more information, please refer to the trimming section located on page 16 of this manual.

At the servo, the stock linkage attachment is a Z-bend located in the outermost hole in the servo arm for the rudder and elevator, and the center hole for the ailerons.

At the control horn, the stock attachment is a nylon clevis located in the outermost hole for aileron/rudder, and innermost hole for elevator.

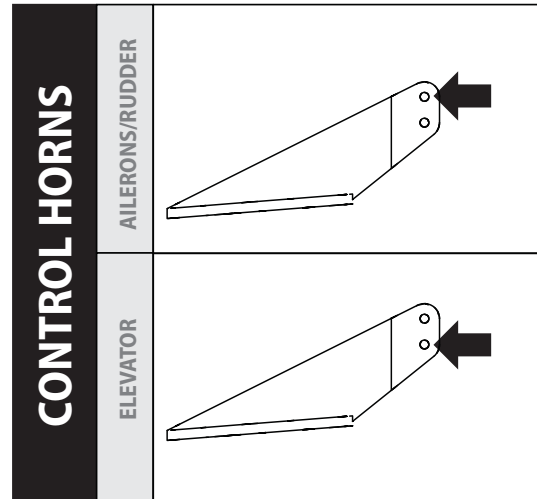
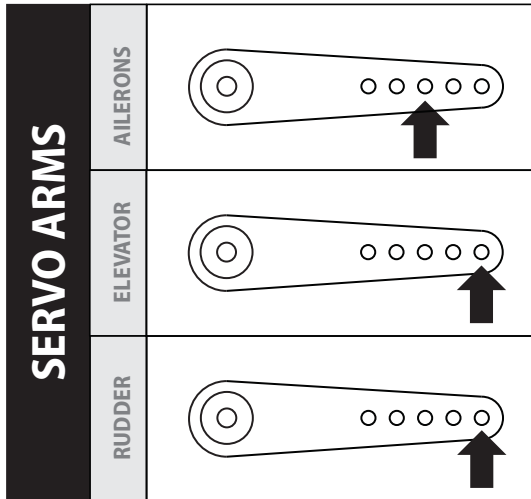

⚠ NOTICE

The DS15 servos installed in your Mamba 10 are high quality, digital servos with all metal gear train and ultra-fine gear mesh. This fine resolution and high tooth count output shaft means that the servo arms pre-installed on the servos may inadvertently be misaligned, yet appear properly installed. It is critical to ensure the positive, perpendicular orientation of the arm to the case to ensure that the travel of the servos is even from side to side at extreme throws, particularly on the rudder servo.

PROPELLER/SPINNER INSTALLATION

Required Tools and Fasteners: #1 Phillips Screwdriver, 13mm Box Wrench, M3x6mm machine screw



1. Insert the prop collet onto the motor shaft. Ensure that it is fully seated.
2. Temporarily remove the prop nut and washer and install the propeller with the convex surface facing forward. The propeller size numbers are printed on the front face of the prop and should orient forward.
3. Slide the prop washer on the collet with the widest face aft, and tighten the prop nut.

⚠ NOTICE

Spin the motor over by hand to ensure that the spinner is true after installation.

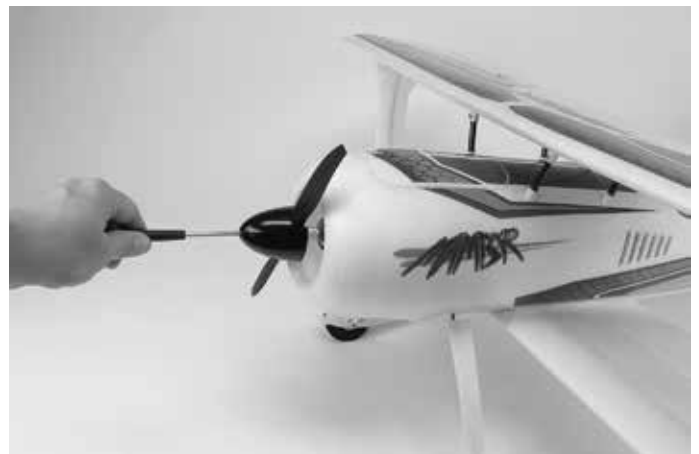

BATTERY INSTALLATION

1. Push the spring-loaded battery latch tab back to release the battery hatch.
2. Press the battery to the battery tray and secure with the provided hook-and-loop strap. With the recommended battery, the front edge align with the front edge of the battery hatch.
3. Reinstall the hatch, and confirm that the latch has positively engaged.



⚠ CAUTION

Always keep limbs clear from the propeller when the battery is connected. After the ESC arms, the propeller will rotate when the throttle is moved. Unlike an internal combustion engine, electric motors apply more voltage to counteract resistance, therefore any object that is entangled in the propeller will be severely damaged before the motor will stop

⚠ WARNING

When making adjustments to linkages, transmitter settings, or the Aura 8 flight control system, remove the propeller to guard against accidental spool up.

CENTER OF GRAVITY

The location of the center of gravity for the Mamba 10 is located **2 9/16-IN (65MM) AFT** of the **LEADING EDGE** of the **BOTTOM WING** and is measured by lifting the completed airplane upright, with all components installed, by the bottom wing. This measurement was determined from many test flights by designer and many time world aerobatic champion, Quique Somenzini. Lift the airplane from the underside of the wing to check the CG.

Setting the center of gravity is one of the most important steps for success, particularly with a new airplane. The Mamba is a high-performance airplane with large control surface throws, and a high thrust to weight ratio. These two factors combined make it a very enjoyable aircraft to fly, but if the center of gravity is not within an acceptable range, it will make the airplane difficult, if not impossible, to control.

NOTICE

The CG measurement should be made with the completed airframe with all components (batteries, servos, receiver, linkages, screws, bolts, hardware, etc.) installed. Failure to do so will result in inaccurate measurement.

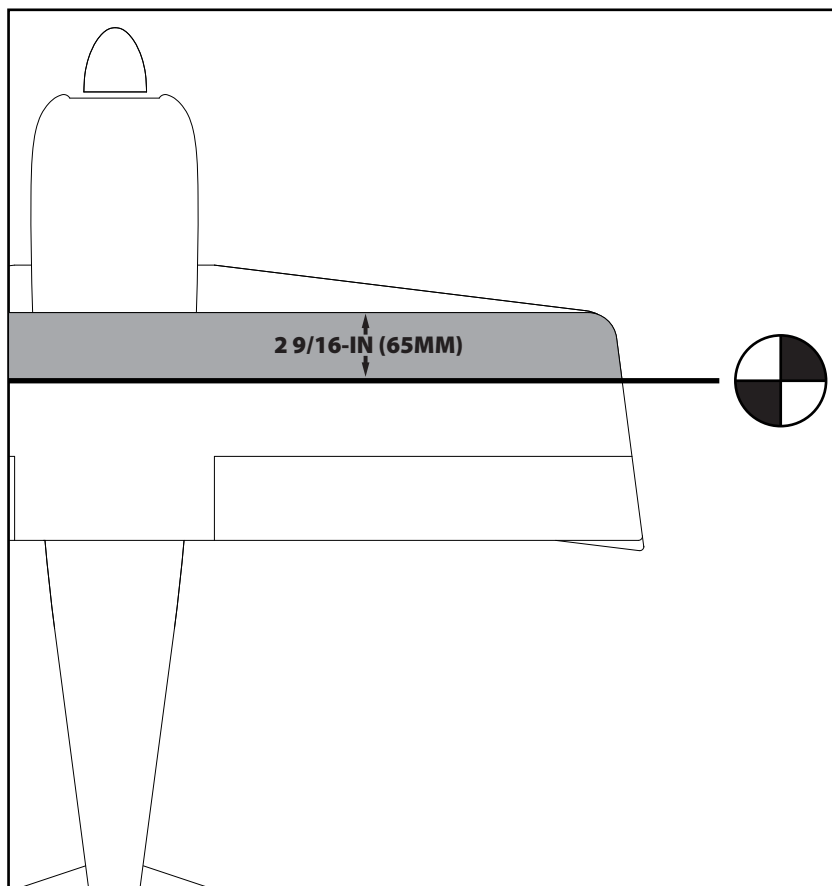

FLYING YOUR MAMBA 10

Selecting a Flying Site

Selecting a flying site is critical to a successful flight. Airplanes require a lot more room than other R/C products, therefore, a neighborhood or parking lot is less than ideal. A large open field with short grass and generous overfly area are the best candidates if no AMA field is available in your area. Know your overfly area - ensure that there are no houses, playgrounds, or other buildings that may be damaged if the airplane were to crash.



Takeoff

Taxi or place the aircraft on the runway centerline, with the nose into the wind. Select Mode 2, then set throttle trim such that the motor spins over smoothly at its lowest RPM without stopping. Smoothly advance to full throttle while maintaining directional control with the rudder and slight back pressure on the elevator. The airplane should lift off gently before the throttle is fully open. Fly in Mode 2 until the aircraft is fully trimmed (see special trimming instructions), and you are comfortable with its handling, then explore the other modes as desired.

Flying

Altitude is your friend on the first flight. Briskly climb to a safe altitude and trim the airplane out. The airplane should fly straight and level a 1/2 to 3/4 power with no hands on the transmitter. Try some basic maneuvers, and slowly progress into the airplane's flight envelope as you become more comfortable with the airplane's flight qualities and perfect your setup. **Note: If at any time, such as after gain adjustments, you experience unexpected control system inputs or oscillations, switch to Mode 1, and land and troubleshoot the issue. (Mode 1 turns the sensor inputs off with default programming)**

Landing

Be mindful of your flight time and allow adequate battery reserve for a couple of go-arounds, if necessary, on the first few flights. Select Mode 2 and slow the airplane and align with the runway, into the wind. The airplane should descend smoothly in this configuration with proper airspeed. Once you are close to the ground, gradually close the throttle fully and begin to smoothly apply up elevator as required to arrest descent and the airplane should gently touch down with a short roll out.

Trimming

The first several flights on your new Mamba 10 should be dedicated to trimming and setup. Fly the airplane at 2/3 power in **Mode 2** and trim for level flight. **Land, adjust linkages and return the trim and/or subtrim to zero and fly again. Repeat process until the airplane flies hands off, straight and level.**

Transmitter trim or sub-trim will cause trim shifts when different flight modes are selected. To eliminate this trim shift, the model should be mechanically trimmed, or Aura "Quick Trim" may be used instead.

Aura Quick Trim

The Aura 8 features a Quick Trim Mode that eliminates the need for mechanical linkage adjustments during test flights. Aura will learn the trim values from your transmitter, and apply them to the control surfaces at power up when enabling quick trim mode.

NOTE: Quick Trim can also be used BEFORE flying to make small changes to center the control surfaces before flight.

1. Fly the airplane in Flight Mode 2. Trim the aircraft with the transmitter and land. **DO NOT CHANGE FLIGHT MODES.**
2. Power off the Mamba. Insert a bind plug into Aura Port S3 (you will need to remove the servo lead that is currently in S3). Check the transmitter is on and repower the Aura.
3. Wait 5 seconds for the Aura to completely initialize. Confirm Quick Trim mode is active by checking the Blue LED is slowly flashing.
4. Remove the bind plug from **Aura Port S3**, and re-install the servo that was previously removed into S3. Removing the bind plug stores the current trims in the Aura. The Blue LED will flash quickly after control surface trim values are stored. While the trim values are stored in Aura, they are not applied to the control surface(s) until the Aura is repowered.
5. Remove power from the Mamba and center all control surface trims on the transmitter.
6. Repower the Mamba. The control surfaces should be unchanged even though the trim has been centered on the transmitter.
7. Switch between other Flight Modes to ensure you do not see any changes in trim.

NOTE: QUICK TRIM MAY BE REPEATED AS NEEDED FOR FINE TUNING, OR IF CHANGES TO THE AIRCRAFT ARE MADE.

NOTE: ENSURE AILERON/ELEVATOR/RUDDER SUB-TRIMS ARE ZERO BEFORE FLYING FOR QUICK TRIM PROCESS

NOTE: QUICK TRIM IS **NOT** AVAILABLE TO PWM CONNECTION USERS. IF YOU ARE USING A PWM CONNECTION TYPE, YOU WILL NEED TO **MECHANICALLY TRIM** THE MODEL



CAUTION

USE CAUTION WHEN FLYING YOUR MAMBA 10 IN MODE 3 AT HIGH AIRSPEEDS. DOING SO CAN INDUCE CONTROL SURFACE OSCILLATIONS AND MAY CAUSE A CRASH.

ADVANCED MAMBA 10 SETUP

The design characteristics of a biplane lend themselves well to advanced aerobatic setup with some configurations and maneuvers that are simply not possible with a monoplane. While the Mamba 10 is optimized in every way to ensure maximum performance in the stock configuration, presented here are several pre-configured upgrades for the advanced flyer that will help elevate the performance and enjoyment of the Mamba 10 to the next level!

Optional 4S Motor Setup

For flyers wanting more power or different flying style, we have developed a plug-and-play 4S power system solution for the Mamba 10 utilizing a custom-modified 1070Kv version of the Potenza 10 motor installed in the stock Mamba 10. In the interest of convenience and simplicity, the existing 50A ESC and propeller are used in the upgraded power system, only the motor and battery are different.

NOTE: The APC 12x4.5MR propeller is also a great choice with this 4S motor and battery combination.

Required Parts and Accessories: FPZM1010D Potenza 10 1070Kv Motor
FPZB22004S40 4S 2200mAh 40C LiPo Battery

Required Tools: #1 Phillips Screwdriver, #2 Phillips Screwdriver, 13mm Box Wrench

1. Use a #2 Phillips screwdriver to remove the spinner cone and a 13mm box wrench to loosen the prop nut. Remove the entire propeller and collet assembly from the motor and set it aside as they will be reused.
2. Use a #1 Phillips screwdriver to remove the motor mounting screws from the firewall. Place the screws aside as they will be reused.
3. Unplug the stock motor from the ESC, noting the color of the wires. Match the color of the wires of the 4S motor when reconnecting.
4. Using the screws removed in step 2, attach the motor back to the firewall with a #1 Phillips screwdriver. **Ensure screws are tight.**
5. Reinstall the prop collet and spinner.

Advanced Mamba 10 Aura 8 Configuration

Expert Flight Modes

The Aura 8 installed in the Mamba 10 is equipped with two possible Aura Configurations — Stock and Expert. **These may be accessed WITHOUT THE USE OF A WINDOWS-BASED PC OR TABLET by using the Aura Quick Set feature.** The "Expert" version offers three flight modes: High Speed 3D, Sport, and Slow Speed 3D.

! NOTICE

The "Expert" flight modes cannot be configured by Quick Set when using PWM Servo Connections to Aura.

Flight Mode 1 - High Speed 3D

For high speed flying (full throttle) at high rate. Ideal for tumbling and high energy aerobatics.

Rate for aileron is 70% while rudder and elevator travelling at max deflection.

Gain are set low and expo are set high.

For information on how to access and setup Aura Quick set, visit <http://wiki.flexinnovations.com/wiki/Mamba10/QuickSet>.

Flight Mode 2 - Sport

For sport or precision aerobatics.

Rates are low, expo adjusted for smooth flight.

Gains are set low.

Flight Mode 3 - Slow Speed 3D

Ideal for harriers, torque rolls, hovering, waterfalls, flat spins, etc.

Rate in all control surface at max.
Gains are set high.

Note: This mode should not be used to fly the airplane at high speed. Control surface oscillation might occur if the airplane is flown at high speed in this mode.

Crow

The Mamba 10 is the only PNP 3D foam biplane on the market in this size with four individual aileron servos instead of two servos with interconnect linkages. This flexibility, usually only found in larger biplanes, allows the Mamba 10 to take advantage of several key aileron setups, primarily the "world famous QQ biplane crow". Crow is used to slowing downlines and helping make amazing short-field landings and is accomplished by simultaneously raising both upper ailerons and lowering both bottom ailerons to increase drag.

In the past, this has required a very advanced transmitter with complex programming, but with the Aura 8, it is as simple as creating and uploading a new Aura Config File before heading to the flying field - no hours of setup and trimming with a complex, expensive transmitter required!

Visit <http://wiki.flexinnovations.com/wiki/Mamba10/Crow> for instructions how to easily create the Crow configuration in the Aura Config Tool and adjust the Aura Servo connections. Please note that a windows-based PC or tablet will be required to upload this file to the Aura 8.

AIRFRAME REPAIRS

The Mamba 10 is molded from durable EPO foam and is repairable with most adhesives. Similar to building and repairing wood or composite airplanes, the correct glue for a given application is critical to the repair holding and not breaking again. For major repairs, such as a broken fuselage, epoxy is preferred because it allows time to correct any misalignment. For smaller repairs, such as a cracked control surface or small chunk of material missing from the airframe, regular CA is very effective. The use of odorless (foam safe) CA is not recommended on EPO foam aircraft because it is weaker than regular CA and takes a longer period of time to cure and the bond tends to be weaker.

NOTE: Avoid the use of CA accelerant in repairs. It can damage paint and will weaken the bond of the glue. If CA accelerant is used, be mindful of the locations of CA to prevent premature bonding of parts, or bonding a hand or clamp to the airframe.

If a part is damaged too badly to be repaired, please refer to the front of the manual for a complete listing of spare airframe parts.

NOTICE: If a crash is imminent, fully reduce the throttle to prevent further damage to the power system and reduce energy to lessen impact damage. Never allow the propeller to contact the ground under power, even idle.

BE ADVISED THAT CRASH DAMAGE IS NOT COVERED UNDER ANY PRODUCT WARRANTY.

Avoid keeping the airplane in direct sunlight when not flying. Excessive heat can damage the airplane's structure and UV damage can permanently discolor decals.

REPLACING AILERON SERVOS

Required Tools and Fasteners: #1 Phillips Screwdriver, #11 or single-edged razor blade

1. Unplug the servo from the receiver.
2. Unscrew the servo arm from the servo and remove the servo arm.
3. Using a sharp blade, carefully cut the tape around the perimeter of the servo. **DO NOT CUT THE SERVO LEAD.**
4. Unscrew the two mounting screws located at each end of the servo and remove.

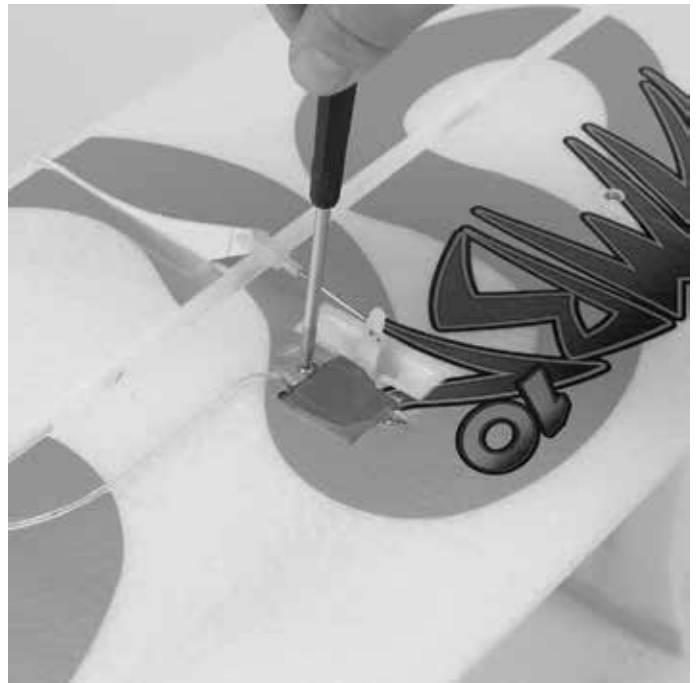

TIP: Plug a spare extension lead into the servo when removing to make it easier to install the lead of the servo when replaced.

SERVICING THE POWER SYSTEM

Required Tools and Fasteners: #1 Phillips Screwdriver, 13mm box wrench

1. Remove the propeller and spinner assembly from the motor.
2. Remove the (4) bolts holding the motor to the firewall using a #1 Phillips screwdriver. Disconnect the motor from the ESC.
3. To remove the ESC, simply unplug its lead from the receiver or Aura and the output leads from the motor.

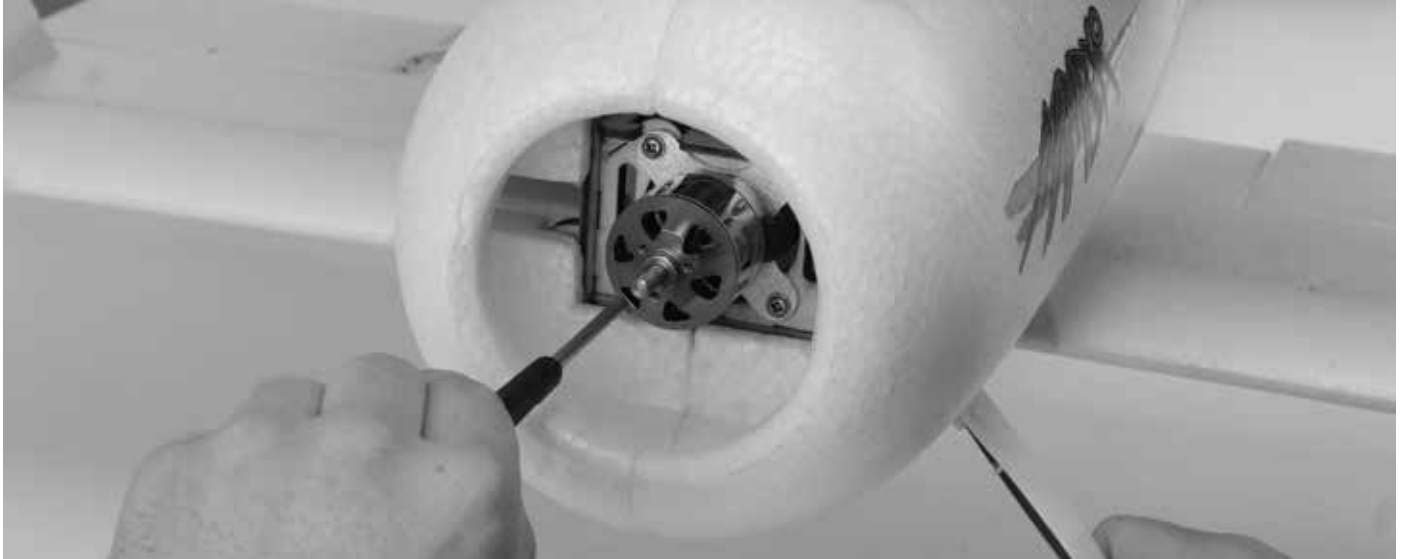

OPTIONAL WHEEL PANT REMOVAL

For flyers that want the lightest possible setup, or that fly off of rough/unimproved fields, the wheelpant on the Mamba 10 are designed to be removable. Two wheel collars have been provided in the hardware bag to retain the wheels after the wheelpants are removed.

Required Tools and Fasteners: #1 Phillips Screwdriver, 1.5mm hex driver, (2) wheel collars

1. Invert the airplane and locate the two wheelpant retaining screws and remove them. Slide the wheelpant and tires off of the axles.
2. Remove the wheel from the wheelpant and reinstall on the axle.
3. Slide the wheel collar onto the axle with the shoulder (offset) side towards the wheel. Tighten the set screw on the wheel collar.

TIP: reinstall the wheelpant retaining collar and screws to prevent losing parts in case you wish to reinstall them.

TIP: use blue threadlocker on the wheel collar set screw for added security.

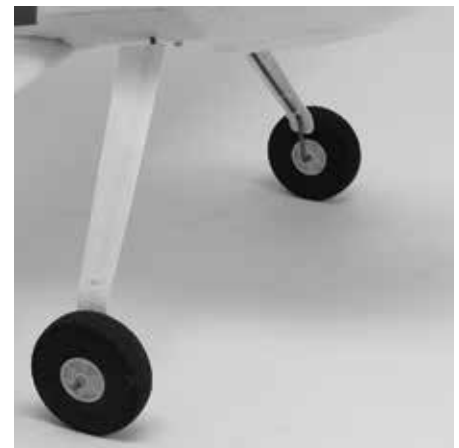
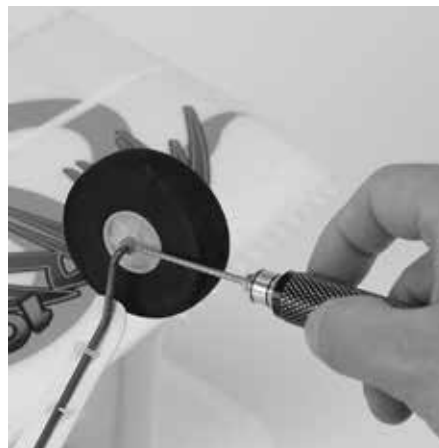

AIRCRAFT TROUBLESHOOTING GUIDE

Should you encounter any abnormal situations with your Mamba 10, refer to the matrix below to determine the probable cause and a recommended solution for the action.

If the required solution does not rectify the problem, please contact product support for further assistance.



NOTICE

Unless specifically required, ALWAYS troubleshoot the airplane with the propeller removed.

DISCREPANCY	PROBABLE CAUSE	RECOMMENDED SOLUTION
Motor nonresponsive (ESC initialization tones audible)	Throttle not at idle and/or throttle trim too high	Lower throttle stick and trim completely. If problem persists, ensure that the sub-trim and travel adjust are properly set in the radio's programming.
	Throttle channel is reversed	Reverse throttle channel in radio programming
Motor nonresponsive (no ESC initialization tones audible)	Motor disconnected from ESC	Ensure plugs are fully seated. Check battery and/or plugs for damage and replace any damaged components found - DO NOT ATTEMPT REPAIR
Motor turns in the wrong direction	The three motor wires are connected incorrectly to the ESC	Swap any TWO motor wires.
Reduced flight time or aircraft underpowered	Trims are not properly zeroed	Ensure battery is fully charged prior to installing in aircraft
	Propeller installed backwards	Install propeller so that the convex side faces forward (tractor configuration)
	Flight battery damaged	Remove battery from service completely and replace with a different battery
	Ambient temperature is too cold	Ensure battery packs are adequately warm (70°F/21°C) before flight
	Battery capacity too small for intended use	Replace battery with one of proper capacity and discharge capacity (C rating)
	ESC reaching preset LVC (low-voltage cutoff)	Recharge flight battery or reduce flight time
	Battery is too weak or damaged	Check battery's physical condition, check battery voltages after charge
Excessive propeller noise and/or vibration	Battery's discharge rating may be too small	Replace battery with one with higher 'C' rating
	Damaged spinner and/or propeller, collet, or motor	Replace damaged components - DO NOT ATTEMPT REPAIR
Excessive propeller noise and/or vibration	Propeller is not balanced	Balance or replace the propeller
	Prop nut is loose	Tighten prop nut with appropriate-sized wrench
	Spinner is not fully in place or tightened	Loosen the spinner bolt, adjust as required, retighten spinner bolt
	Propeller nut or propeller adapter threads not cut straight	Replace propeller nut or propeller shaft - DO NOT ATTEMPT REPAIR
	Airframe or control linkage system damage	Examine airframe for damage, repair as required; inspect control linkage system (servo, pushrod, control horn) for damaged components and replace as required
Control surfaces nonresponsive	Wire damaged or connector loose	Examine wires and connections, replace as necessary
	Transmitter bound incorrectly, incorrect active model memory, incorrect Aura data input configuration, incorrect Aura transmitter settings	Consult radio manual for proper binding and model selection instructions
	Battery voltage too low	Use volt meter to check battery; recharge or replace as necessary
	Battery disconnected from ESC	Check that the EC3 plugs are fully seated
	BEC (battery elimination circuit) damaged	Replace ESC - DO NOT ATTEMPT REPAIR
	Damaged Servo	Replace Servo - DO NOT ATTEMPT REPAIR
	Failed control direction test	Incorrect Aura 8 or Transmitter Setting - DO NOT FLY!
Controls reversed	Aura 8 or transmitter settings incorrect	Refer to control surface direction chart and transmitter setup; adjust appropriate settings as required. Check Mamba 10 and Aura wiki web pages for additional information. Contact customer support at support@flexinnovations.com
Control surface oscillation	Exceeding maximum airspeed for configuration	Reduce airspeed
	Gains too high for aircraft/flight configuration	Refer to Aura 8 manual to decrease desired control surface gain
	Propeller/spinner not balanced	Balance or replace propeller and/or spinner
	Motor vibration	Inspect motor mounting bolts and re-tighten as necessary
	Loose Aura 8 mounting	Re-align and secure the Aura 8 to the aircraft
	Control linkage slop	Examine control system and repair or replace work components
	Improper transmitter setup	Refer to Aura 8 manual to correctly configure transmitter
	Damaged propeller or spinner	Replace damaged component- DO NOT ATTEMPT REPAIR
Trim changes between flight modes	Improperly set master gain	Ensure master gain is set for proper gain value
	Trims are not properly zeroed	Readjust control linkage and re-center trims in radio
	Sub-trim is not properly zeroed	Remove sub-trim; adjust the servo arm or clevis to achieve proper geometry
PWM connection type and cannot get orange+green Aura and control of model	Transmitter is not properly calibrated (aileron/elevator/rudder are not neutral with sticks centered; reference transmitter monitor)	Calibrate transmitter (reference manufacturer's instructions, or return to manufacturer for calibration)
	Any of four PWM servo cables are not connected	Connect all four male to male servo cables between your receiver and Aura
	PWM servo cables connected to incorrect ports	Reconnect cables to proper ports. Reference chart on page XX
	Polarity of PWM servo cables not correct	Reconnect servo cables with proper polarity. Reference chart on page XX
PWM connection type and cannot get orange+green Aura and control of model	Receiver not bound and/or outputting PWM servo pulses	Bind receiver per manufacturer instructions and verify with a servo to ensure PWM signal is output from each channel as required.

LIMITED WARRANTY

Warranty Coverage

Flex Innovations, Inc. and its authorized resellers ("Flex") warrant to the original purchaser that the product purchased (the "Product") it will be free from defects in materials and workmanship at the date of purchase.

Outside of Coverage

This warranty is not transferable and does not cover:

- (a) Products with more than 45 days after purchased date.
- (b) Damage due to acts of God, accident, misuse, abuse, negligence, commercial use, or due to improper use, installation, operation or maintenance
- (c) Modification of or to any part of the Product.
- (d) Product not compliant with applicable technical regulations.
- (e) Shipping damage.
- (f) Cosmetic damage

OTHER THAN THE EXPRESS WARRANTY ABOVE, FLEX MAKES NO OTHER WARRANTY OR REPRESENTATION, AND HEREBY DISCLAIMS ANY AND ALL IMPLIED WARRANTIES, INCLUDING, WITHOUT LIMITATION, THE IMPLIED WARRANTIES OF NONINFRINGEMENT, MERCHANTABILITY AND FITNESS FOR A PARTICULAR PURPOSE. THE PURCHASER ACKNOWLEDGES THAT THEY ALONE HAVE DETERMINED THAT THE PRODUCT WILL SUITABLY MEET THE REQUIREMENTS OF THE PURCHASER'S INTENDED USE.

Purchaser's Solution

Flex's sole obligation and purchaser's sole and exclusive remedy shall be that Flex will, at its option, either (i) service, or (ii) replace, any Product determined by Flex to be defective. Flex reserves the right to inspect any and all Product(s) involved in a warranty claim. Service or replacement decisions are at the sole discretion of Flex. Proof of purchase is required for all warranty claims. **SERVICE OR REPLACEMENT AS PROVIDED UNDER THIS WARRANTY IS THE PURCHASER'S SOLE AND EXCLUSIVE REMEDY.**

Limitation of Liability

FLEX SHALL NOT BE LIABLE FOR SPECIAL, INDIRECT, INCIDENTAL OR CONSEQUENTIAL DAMAGES, LOSS OF PROFITS OR PRODUCTION OR COMMERCIAL LOSS IN ANY WAY, REGARDLESS OF WHETHER SUCH CLAIM IS BASED IN CONTRACT, WARRANTY, TORT, NEGLIGENCE, STRICT LIABILITY OR ANY OTHER THEORY OF LIABILITY, EVEN IF FLEX HAS BEEN ADVISED OF THE POSSIBILITY OF SUCH DAMAGES.

Further, in no event shall the liability of Flex exceed the individual price of the Product on which liability is asserted. As Flex has no control over use, setup, assembly, modification or misuse, no liability shall be assumed nor accepted for any resulting damage or injury. By the act of use, setup or assembly, the user accepts all resulting liability. If you as the purchaser or user are not prepared to accept the liability associated with the use of the Product, purchaser is advised to return the Product immediately in new and unused condition to the place of purchase.

Law

These terms are governed by Florida law (without regard to conflict of law principals). This warranty gives you specific legal rights, and you may also have other rights which vary from state to state. **FLEX RESERVES THE RIGHT TO MODIFY THIS WARRANTY AT ANY TIME WITHOUT PRIOR NOTICE.**

Questions & Assistance

Visit <http://www.flexinnovations.com/flex-authorized-reseller> for customer support in your region.

Inspection or Services

If this Product needs to be inspected or serviced and is compliant in the region you live and use the Product in, please contact your regional Flex authorized reseller. Pack the Product securely using a shipping carton. Please note that original boxes needs to be included, but are not designed to withstand the rigors of shipping without additional protection. Ship via a carrier that provides tracking and insurance for lost or damaged parcels, as Flex is not responsible for merchandise until it arrives and is accepted at our facility.

Warranty Requirements

For Warranty consideration, you must include your original sales receipt verifying the proof of purchase date. Provided warranty conditions have been met, your Product will be replaced free of charge. Shipping charges are as follow: to Flex by customer, Flex out it is by Flex. Service or replacement decisions are at the sole discretion of Flex.

COMPLIANCE INFORMATION FOR THE EUROPEAN UNION

 **Declaration of Conformity** (In accordance with ISO/IEC 17050-1)

Product(s): Mamba 10 Super PNP
Item Number(s): FPR3270A/FPR3270B

The object of declaration described above is in conformity with the requirements of the specifications listed below, following the provisions of the EMC Directive 2004/108/EC.

EN 55022: 2010+AC: 2011

EN 55024: 2010

EN 61000-3-2: 2006+A2:2009

EN 61000-3-3: 2013

EN 61000-6-3: 2007/A1:2011

EN 61000-6-1: 2007



Instructions for disposal of WEEE by users in the European Union

This product must not be disposed of with other waste. Instead, it is the user's responsibility to dispose of their waste equipment by handing it over to a designated collections point for the recycling of waste and electronic equipment. The separate collection and recycling of your waste equipment at the time of disposal will help to conserve natural resources and ensure that it is recycled in a manner that protects human health and the environment. For more information about where to drop off your waste equipment for recycling, please contact your local city office, your household waste disposal service or where you purchased the product.



Academy of Model Aeronautics National Model Aircraft Safety Code Effective January 1, 2014

A. **GENERAL:** A model aircraft is a non-human-carrying aircraft capable of sustained flight in the atmosphere. It may not exceed limitations of this code and is intended exclusively for sport, recreation, education and/or competition. All model flights must be conducted in accordance with this safety code and any additional rules specific to the flying site.

1. Model aircraft will not be flown:
 - (a) In a careless or reckless manner.
 - (b) At a location where model aircraft activities are prohibited.
2. Model aircraft pilots will:
 - (a) Yield the right of way to all human-carrying aircraft.
 - (b) See and avoid all aircraft and a spotter must be used when appropriate. (AMA Document #540-D.)
 - (c) Not fly higher than approximately 400 feet above ground level within three (3) miles of an airport without notifying the airport operator.
 - (d) Not interfere with operations and traffic patterns at any airport, heliport or seaplane base except where there is a mixed use agreement.
 - (e) Not exceed a takeoff weight, including fuel, of 55 pounds unless in compliance with the AMA Large Model Airplane program. (AMA Document 520-A.)
 - (f) Ensure the aircraft is identified with the name and address or AMA number of the owner on the inside or affixed to the outside of the model aircraft. (This does not apply to model aircraft flown indoors.)
 - (g) Not operate aircraft with metal-blade propellers or with gaseous boosts except for helicopters operated under the provisions of AMA Document #555.
 - (h) Not operate model aircraft while under the influence of alcohol or while using any drug that could adversely affect the pilot's ability to safely control the model.
 - (i) Not operate model aircraft carrying pyrotechnic devices that explode or burn, or any device which propels a projectile or drops any object that creates hazard to persons or property.

Exceptions:

- Free Flight fuses or devices that burn producing smoke and are securely attached to the model aircraft during flight.
 - Rocket motors (using solid propellant) up to a G-series size may be used provided they remain attached to the model during flight. Model rockets may be flown in accordance with the National Model Rocketry Safety Code but may not be launched from model aircraft.
 - Officially designated AMA Air Show Teams (AST) are authorized to use devices and practices as defined within the Team AMA Program Document. (AMA Document #718.)
- (j) Not operate a turbine-powered aircraft, unless in compliance with the AMA turbine regulations. (AMA Document #510-A.)
 3. Model aircraft will not be flown in AMA sanctioned events, air shows or model demonstrations unless:
 - (a) The aircraft, control system and pilot skills have successfully demonstrated all maneuvers intended or anticipated prior to the specific event.
 - (b) An inexperienced pilot is assisted by an experienced pilot.
 4. When and where required by rule, helmets must be properly worn and fastened. They must be OSHA, DOT, ANSI, SNELL or NOCSAE approved or comply with comparable standards.

B. RADIO CONTROL (RC)

1. All pilots shall avoid flying directly over unprotected people, vessels, vehicles or structures and shall avoid endangerment of life and property of others.
2. A successful radio equipment ground-range check in accordance with manufacturer's recommendations will be completed before the first flight of a new or repaired model aircraft.
3. At all flying sites a safety line(s) must be established in front of which all flying takes place. (AMA Document #706.)
 - (a) Only personnel associated with flying the model aircraft are allowed at or in front of the safety line.
 - (b) At air shows or demonstrations, a straight safety line must be established.
 - (c) An area away from the safety line must be maintained for spectators.
 - (d) Intentional flying behind the safety line is prohibited.

4. RC model aircraft must use the radio-control frequencies currently allowed by the Federal Communications Commission (FCC). Only individuals properly licensed by the FCC are authorized to operate equipment on Amateur Band frequencies.
5. RC model aircraft will not knowingly operate within three (3) miles of any pre-existing flying site without a frequency-management agreement. (AMA Documents #922 and #923.)
6. With the exception of events flown under official AMA Competition Regulations, excluding takeoff and landing, no powered model may be flown outdoors closer than 25 feet to any individual, except for the pilot and the pilot's helper(s) located at the flightline.
7. Under no circumstances may a pilot or other person touch an outdoor model aircraft in flight while it is still under power, except to divert it from striking an individual.
8. RC night flying requires a lighting system providing the pilot with a clear view of the model's attitude and orientation at all times. Hand-held illumination systems are inadequate for night flying operations.
9. The pilot of an RC model aircraft shall:
 - (a) Maintain control during the entire flight, maintaining visual contact without enhancement other than by corrective lenses prescribed for the pilot.
 - (b) Fly using the assistance of a camera or First-Person View (FPV) only in accordance with the procedures outlined in AMA Document #550.
 - (c) Fly using the assistance of autopilot or stabilization system only in accordance with the procedures outlined in AMA Document #560.

C. FREE FLIGHT

1. Must be at least 100 feet downwind of spectators and automobile parking when the model aircraft is launched.
2. Launch area must be clear of all individuals except mechanics, officials, and other fliers.
3. An effective device will be used to extinguish any fuse on the model aircraft after the fuse has completed its function.

D. CONTROL LINE

1. The complete control system (including the safety thong where applicable) must have an inspection and pull test prior to flying.
2. The pull test will be in accordance with the current Competition Regulations for the applicable model aircraft category.
3. Model aircraft not fitting a specific category shall use those pull-test requirements as indicated for Control Line Precision Aerobatics.
4. The flying area must be clear of all utility wires or poles and a model aircraft will not be flown closer than 50 feet to any above-ground electric utility lines.
5. The flying area must be clear of all nonessential participants and spectators before the engine is started.

If you are not an AMA member, please consider joining. Founded in 1936 and open to anyone interested in model aviation, the AMA is the governing body for model aviation in the United States and sanctions over 2,000 competitions annually. Membership in the AMA provides liability insurance coverage, protects modelers' rights and interests, and is required to fly at most of the 2,700+ R/C sites nationwide.

Academy of Model Aeronautics
5161 East Memorial Drive
Muncie, IN 47302-9252
Toll Free (800) 435-9262
Fax (765) 741-0057

www.modelaircraft.org



www.flexinnovations.com



Officially Licensed Product

© 2017 Flex Innovations, Inc.
Premier Aircraft™, Potenza™, and Top Value RC™ are trademarks or registered trademarks of Flex Innovations, Inc.
DSM®, DSM2™, and DSMX™ are trademarks of Horizon Hobby, Inc.
Futaba is a registered trademark of Futaba Denshi Kogyo Kabushiki Kaisha Corporation of Japan.
Jeti, UDI, and Jeti Model are trademarks or registered trademarks of Jelen, Ing. Stanislav of Czech Republic
HoTT is a registered trademark of SJ, Inc.