

# ASCENT FUSION

1/10 Scale Brushless Crawler



MOST RECENT FULL  
ONLINE MANUAL

## INCLUDED

**Ascent:** Assembled with electronics  
**Radio System:** 2.4GHz

## REQUIRED

**Rechargeable Battery:** 2S/3S LIPO Soft Pack  
**Battery Charger:** Suitable for battery being used  
**Transmitter Batteries:** Four AA batteries

## IMPORTANT LINKS:

- To view the full length manual with ESC guide, Radio guide, exploded views and parts lists, go to: [www.redcatracing.com/pages/manuals](http://www.redcatracing.com/pages/manuals)
- Link to electric vehicles manual:  
[www.redcatracing.com/manuals/ELECTRIC-MANUAL.pdf](http://www.redcatracing.com/manuals/ELECTRIC-MANUAL.pdf)



# Warnings

**AGE WARNING!** You must be 14 years of age or older to operate this vehicle. It is the buyer's responsibility to ensure that this product is safely operated. This radio controlled (RC) vehicle is not a toy. It is the responsibility of the parents or guardian to ensure that minors receive appropriate guidance and supervision when operating or working on this product.

The buyer assumes all risks associated with the use of this product. Namero LLC d/b/a Redcat Racing and their retail partners, dealers, distributors, manufactures and affiliates cannot control the use and operation of this product and as such shall not be held responsible or liable for any injury, accident or damage resulting from the use of this product.

Always perform a prerun inspection to ensure that there is no damage and that all screws and wheel nuts are secure. If damage is found, repair or replace prior to use.

Fully read all instructions, manuals and warnings that come with your RC vehicle and any accessories required to operate the product.

Never operate your RC vehicles on public roads, near bystanders, children, pets other animals. Never lose sight of your vehicle while it is in operation and always leave a safe distance around your RC vehicles when driving so that in the event you lose control you don't damage the vehicle, hurt yourself or others. Always keep clear of the wheels or other moving parts on the vehicle and never attempt to pick up the vehicle if the wheels are in motion. Do not attempt to touch the motor/ESC, battery or other electrical components during or immediately after use as these items will get hot during operation.

Always allow the vehicle time to cool down between runs. Overheating the electronics can shorten the life of your electronic components.

Never leave the battery connected when not in use and store batteries in accordance with the manufactures instructions.

Never leave a battery unattended while being charged. Never charge batteries while they are inside of the RC vehicle.

There is a risk of fire and explosion when dealing with batteries. Rechargeable batteries may become hot and catch fire if left unattended, charged too quickly, charged too often, if overcharged, if over discharged or if previously damaged. Never charge at a rate higher than 1C. (2000Mah pack = 2 amp charge rate). Always use a LIPO safe charging pouch when charging LIPO batteries. Only use a LIPO specific charger when charging LIPO batteries.

Never use a LIPO battery that has previously overheated and/or shows signs of damage or swelling. If you suspect the battery to be damaged, immediately discontinue use and properly dispose of the battery. Never dispose of a LIPO battery with regular trash, check with local authorities for proper disposal.

Always check the ESC settings to ensure that they match the battery type during operation. If using a LIPO battery, the ESC must be set to LIPO or damage may occur.

Never mix old and new batteries. Do not change or charge batteries in a hazardous location. Do not mix alkaline, lithium, standard (carbon zinc), or rechargeable (NiMh, cadmium) batteries.

If you do not agree with or are unable to follow these warnings and are not willing to accept full and complete liability for the use of this RC product; immediately return the product to your place of purchase in new and unused condition.

# Start Up

**Attention:** The chart to the right shows the RTR settings for the motor/ESC. This is intended to be used as a quick reference guide. To learn more about these settings, how to change them, and other important ESC features, please refer to the ESC section of the online manual.

**Note:** Scan the QR code on the cover of this manual to view the online manual.

Item	Option 1	Option 2	Option 3	Option 4	Option 5	Option 6
Cutoff Voltage	Disabled	Low	Intermediate	High		
Motor Rotation	CCW	CW				
Drag Brake Force	Disabled	Level 1	Level 2	Level 3	Level 4	Level 5
Drag Brake Rate	Level 1	Level 2	Level 3	Level 4	Level 5	

**1.** Insert 4 brand new AA batteries into the controller. Be sure to line up the positive (+) side of the battery with the (+) mark inside the battery compartment. (see above warnings)

**2.** Remove the body clips and rotate the body forward. Unclip hinge to remove.

**3.** Strap in a fully charged battery pack.

**4.** Plug in the battery. CAUTION! Do not turn on the ESC yet!

**5.** Turn on the radio.

**6.** Turn on the ESC and secure the body in place.

**NOTE:** You can also operate the ON/OFF button by reaching under the front right fender.

## Steering

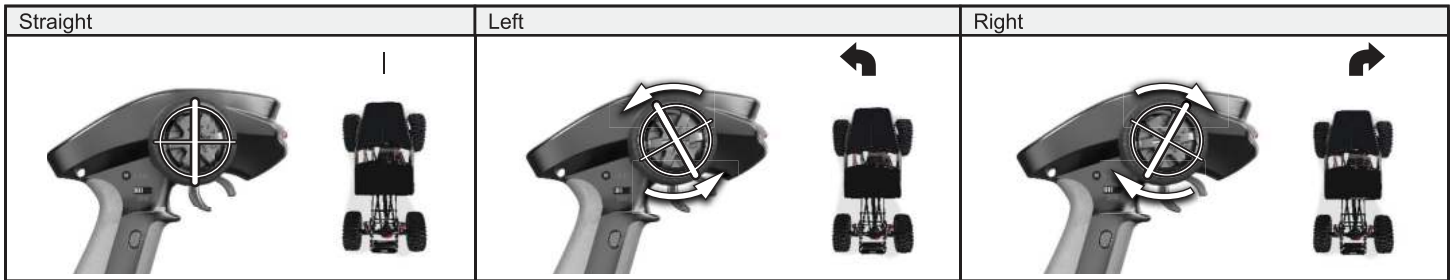

## Throttle



## Shut Down



## Radio Adjustments

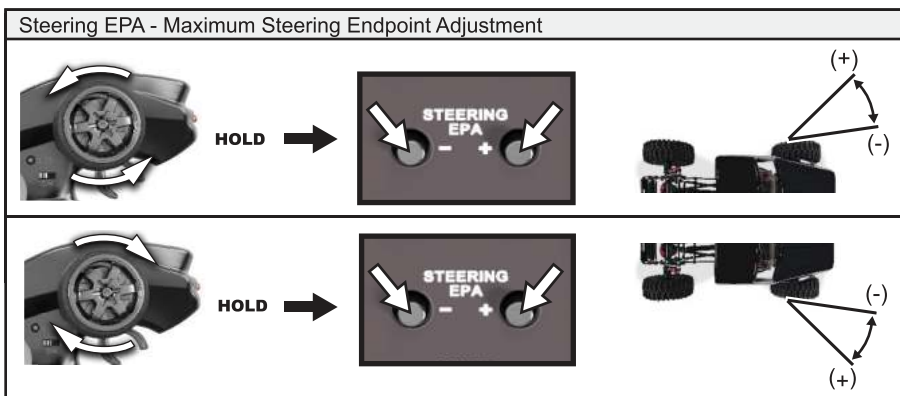
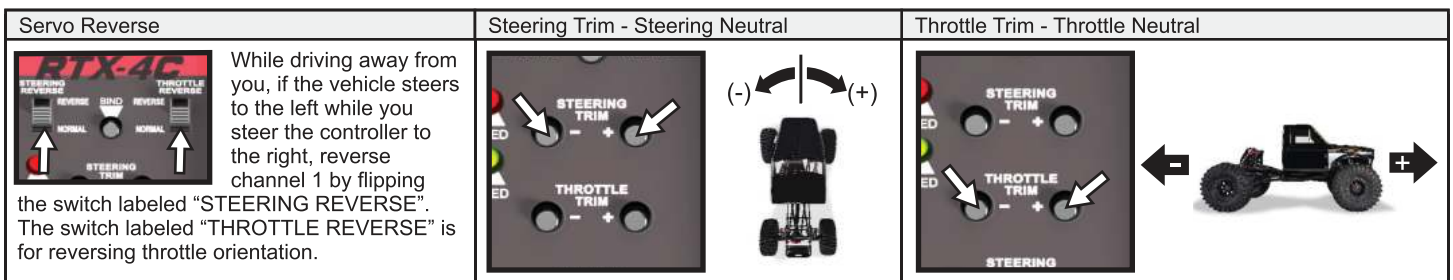

# RTX-4C RADIO GUIDE

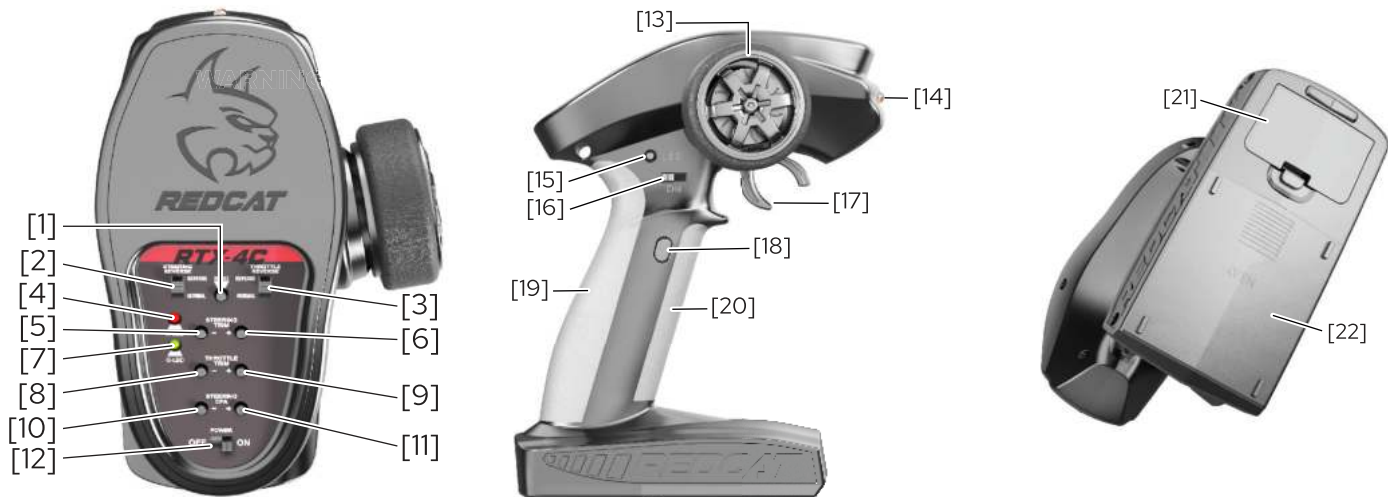

1. Bind Button	12. Power Switch
2. Steering Reverse	13. Steering Wheel (CH1)
3. Throttle Reverse	14. LED Light
4. Power Indicator LED - RED (R. LED)	15. LED Light (ON/OFF) Button
5. Steering Trim (-)	16. Three Position Switch (CH4)
6. Steering Trim (+)	17. Throttle Trigger (CH2)
7. Status Indicator LED - Green (G.LED)	18. Button (CH3)
8. Throttle Trim (-)	19. Rubber Grip Rear
9. Throttle Trim (+)	20. Rubber Grip Front
10. Steering End Point Adjustment (-) (EPA)	21. Tool & Spare Parts Compartment
11. Steering End Point Adjustment (+) (EPA)	22. Battery Compartment - 4 AA Batteries

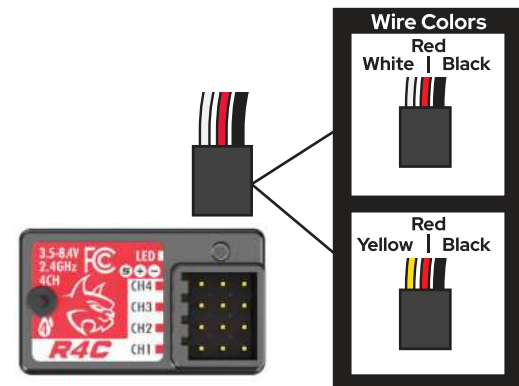

## Warnings and Compliance



FCC Compliance Statement! The radio included with your vehicle complies with part 15 of the FCC Rules. Operation is subject to the following two conditions: (1) This device may not cause harmful interference, and (2) This device must accept any interference received, including interference that may cause undesired operations.

**Note:** This equipment has been tested and found to comply with the limits for a Class B digital device, pursuant to Part 15 of the FCC Rules.

These limits are designed to provide reasonable protection against harmful interference in a residential installation. This equipment generates, uses and can radiate radio frequency energy and, if not installed and used in accordance with the instructions, may cause harmful interference to radio communications. However, there is no guarantee that interference will not occur in a particular installation. If this equipment does cause harmful interference to radio or television reception, which can be determined by turning the equipment off and on, the user is encouraged to try to correct the interference by one of the following measures:

- Reorient or relocate the receiving antenna.
- Increase the separation between the equipment and receiver.
- Connect the equipment into an outlet on a circuit different from that to which the receiver is connected.
- Consult the dealer or an experienced radio/TV technician for help.

### TX

FCC ID: 2A2UNRTX4C00

IC: 24025-RTX4C00

This device complies with Industry Canada license-exempt RSS standard(s). Operation is subject to the following two conditions: (1) This device may not cause interference, and (2) this device must accept any interference, including interference that may cause undesired operations of this device.

**WARNING:** Any changes or modifications not expressly approved by the party responsible for compliance could void the user's authority to operate this equipment.

**WARNING:** While operating the Radio, a separation distance of at least 20 centimeters must be maintained between the radiating antenna and the body of the user or nearby persons in order to meet the FCC RF exposure guidelines.

AFHDS (automatic frequency hopping digital system)

AFHDS was developed for Radio control models and offers active and passive anti-jamming capabilities, low power consumption and high receiver sensitivity.

This radio system works in the frequency range of 2.405 to 2.475GHz. This band has been divided into 141 independent channels. Each radio system uses 16 different channels and 142 different types of hopping algorithm. By using various switch-on times, hopping scheme, and channel frequencies, the system is less likely to lose transmission.

Each transmitter has a unique ID. When binding with a receiver, the receiver saves that unique ID and can accept only data from that unique transmitter.



This avoids picking another transmitter signal and dramatically increases interference immunity and safety.

**WARNING:** Even with the AFHDS 2A-BS technology, if the radio system is not used in accordance with this manual, it can still fail and cause serious injury. Be sure to read and understand this entire manual, as well as the manual that came with all other RC components you are using.



## Receiver Connections

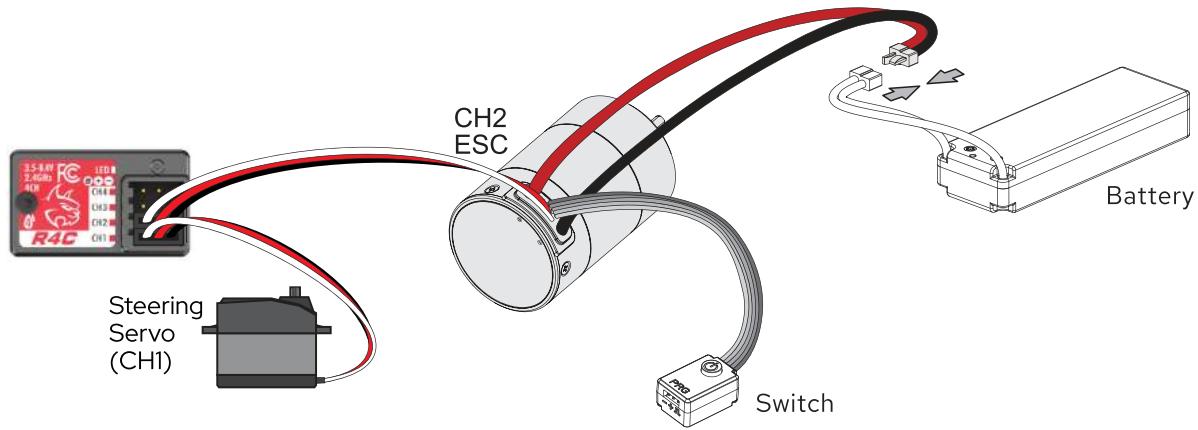

## Binding Process

**NOTE:** The radio is already bound from the factory and only needs to be done if the receiver can't find the radio's signal. Before attempting to bind the radio, be sure there are new batteries in the radio, a fully charged battery pack in the vehicle, and that both are turned on.

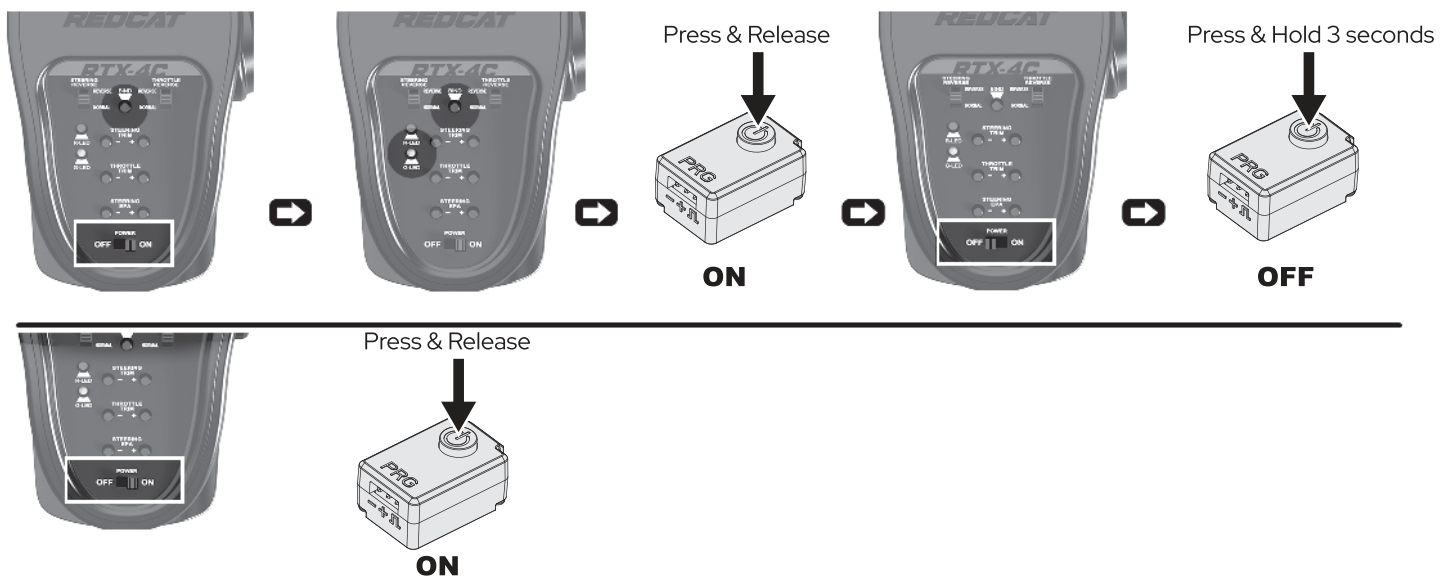

## Calibration

This function is used to set the neutral position for the throttle trigger and steering wheel.

Every transmitter is calibrated before leaving the factory, however if recalibration is required, please follow these steps:

1. Turn and hold the wheel as far clockwise as it will turn, move the throttle trigger to the full reverse position and turn on the transmitter. If done correctly, both Red and Green LEDs will double flash on and off.
2. Calibrate wheel: Turn the wheel completely clockwise, then completely counterclockwise.
  - When calibration is completed the Red LED will turn off.
3. Trigger calibration: Pull the trigger to the full throttle position.
  - When calibration is completed the Green LED will turn off.
4. Once calibration is complete press the bind button to save the settings and exit calibration mode.

## Radio Functions

### -CHANNEL DESCRIPTION-

The transmitter outputs a total of 4 channels, which are allocated as follows:

**CH1:** Steering Wheel

**CH2:** Throttle Trigger

**CH3:** Accessory Button (2 Position button)

**CH4:** Accessory Switch (3 Position Switch)

**Note:** By default the output of CH3 is in the position of 1000us. Pressing the button will toggle between 1000 and 2000us.

### -CHANNEL REVERSE-

This function is used to adjust each channel's direction of movement in relation to its input. The STEERING REVERSE and THROTTLE REVERSE switches directly effect CH1 and CH2. If the switch is up, the channel is reversed. If the switch is down, the channel is in its normal orientation.

### -TRIMS-

The STEERING TRIM buttons are used to center the steering servo (CH1). If the vehicle steers without transmitter steering input, use these buttons to adjust the vehicle so that it drives straight without steering input from the transmitter. STEERING TRIM can be multiplexed to trim CH3 and CH4. For multiplexing instructions, refer to the [Mode Switching] section.

The THROTTLE TRIM buttons are used to ensure the vehicle remains still while there is no transmitter throttle input (CH2). If the vehicle drives forward or backward without transmitter throttle input, use these buttons to trim the throttle until the vehicle is completely still.

Adjustment range: -120us- + 120us, each step is 4us.

STEERING TRIM + / THROTTLE TRIM +: Increases adjustment steps.

STEERING TRIM- / THROTTLE TRIM -: Decreases adjustment steps.

#### LED Indicator:

- While using the trim buttons, the G.LED flashes slowly on short presses and quickly on long presses.
- When the trim adjustment value is in the neutral position, the G.LED will flash twice slowly.
- When the trim adjustment value is at its maximum setting (+ 120us / -120us), the G.LED will no longer flash with each press of the button, indicating it is at its maximum value.

### -END POINT ADJUSTMENTS (EPA)-

STEERING EPA is used to set the steering servo's maximum amount of travel. This is used to ensure the steering servo provides enough throw to steer the front wheels to their maximum capacity without damaging the servo. To set the steering end points, press the "STEERING EPA (-)" button several times, then turn and hold the transmitter's steering wheel all the way to one side. Gradually press the "STEERING EPA (+)" button until front wheels have reached their maximum steering capacity. If you hear the steering servo buzzing, press the "STEERING EPA (-)" until the buzzing stops.

The end point adjustments can be multiplexed to adjust CH2 (throttle), CH3 and CH4. For multiplexing instructions, refer to the [Mode Switching] section.

Adjustment range: 0-120%(the default is 100%), the step value is 5%.

STEERING EPA +: Increases servo travel.

STEERING EPA -: Decreases servo travel.

#### LED Indicator:

- When using the trim keys the G.LED will flash slowly on short presses and quickly on long presses.
- When the end point adjustment value is at its maximum setting, the G.LED will no longer flash with each press of the button.

### -MODE SWITCHING-

This function is for reusing the STEERING TRIM and STEERING EPA buttons for different channels. Refer to the [Trims] and [END POINT ADJUSTMENTS (EPA)] sections above to view their effect on the vehicle.

#### Function settings:

After turning on the transmitter, quickly press the Bind button twice (within 1 second) to cycle through modes 1, 2, 3, and 4. The default setting when powered on is mode 1.

**Mode 1:** G.LED flashes slowly once, STEERING TRIM adjusts CH1 and STEERING EPA adjusts CH1.

**Mode 2:** G.LED flashes twice slowly, STEERING TRIM adjusts CH1 and STEERING EPA adjusts CH2.

**Mode 3:** G.LED flashes three times slowly, STEERING TRIM adjusts CH3 and STEERING EPA adjusts CH3.

**Mode 4:** G.LED flashes slowly four times, STEERING TRIM adjusts CH4 and STEERING EPA adjusts CH4.

### -FAILSAFE-

This function dictates what the receiver will do in the event that it loses signal from the transmitter, this includes servo position, throttle position, etc.

#### Function settings:

1. Turn on the transmitter and make sure it is connected to the receiver.

2. Hold the control surface at the desired failsafe position.

3. Press and hold the bind button for 3 seconds, the G.LED will flash for 2 seconds, indicating that the settings were saved.

**Note:** The failsafe function is not set at the factory by default. If no failsafe setting has been set, the receiver will maintain the output of the last signal when the signal is lost. Failsafe is intended as a safety measure during transmitter signal loss and will not work if the receiver loses power.

### -BEGINNER MODE-

Beginner mode is designed for the people who are new to the hobby.

In this mode the throttle is limited to 50 percent and the channel range defaults are set to 1250~1500~1750us.

#### Function settings:

To switch between beginner and normal modes, press and hold the CH3 button while turning the steering wheel completely counterclockwise, as far as it can go. While holding, turn on the transmitter.

**Note:** By default, the system is set to normal mode. When set to beginner mode, the G.LED will double flash for 3 seconds after turning on the transmitter.

## FUSION RTR - MOTOR/ESC GUIDE

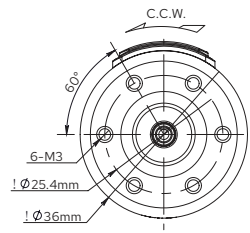
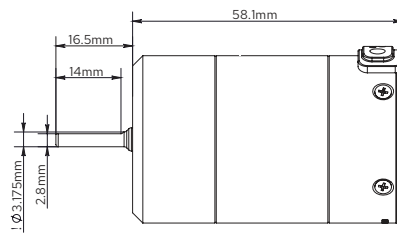

### Specifications

FUSION RTR - ESC/MOTOR	
CONTINUOUS CURRENT	40A
MAIN APPLICATIONS	1/10 CRAWLER
LIPO CELLS	2-3S LIPO, 6-9 CELLS NIMH
BEC OUTPUT	7.4V CONTINUOUS CURRENT 4A
SIZE/WEIGHT	36mm(DIAMETER) X 58.1mm(LENGTH) / 201g (INCLUDING WIRES & CONNECTORS)
PROGRAMMING PORT	INDEPENDENT PROGRAMMING INTERFACE (ON THE ON/OFF SWITCH BOX)
MOTOR KV	1800KV
DIAMETER / LENGTH OF MOTOR	36mm / 58.1mm
SHAFT DIAMETER / EXPOSED SHAFT LENGTH	3.175mm / 16.5mm
MOTOR POLES	4

### Features

- The integrated design of the ESC and the motor greatly reduces overall volume and weight, making layout and wiring simpler and more convenient.
- High torque and smooth running at very low speeds, which is far superior to common sensed brushless power systems and even rivals brushed power systems at low speeds.
- High efficiency results in low operating temperatures, which extends product longevity. The motor also runs quietly and is very responsive to minor throttle input variations, resulting in maximum control.
- With a protection grade of IP67, the entire system has excellent splash and dust resistance. The whole system can easily handle various weather conditions.
- Intelligent torque output and speed closed-loop control. The system automatically adjusts torque output as the resistance of the motor changes, resulting in smooth steep slope slow descents.
- Five levels of adjustable drag brake force allows the driver to control how the vehicle behaves on steep slopes when they let their finger off the trigger.
- Multiple protection functions: battery low voltage protection, system overheat protection, throttle loss protection, and drivetrain lock-up protection.
- Supports an LED program box to set the ESC parameters, which makes setting parameters more convenient and with less guess work.

### Warnings & Compliance

- Please make sure that all wires and connections are well insulated before the ESC is connected to a battery, because a short circuit will damage the ESC.
- Please make all connections carefully. If connected improperly, you may experience abnormal control and/or equipment damaged may occur.
- If you need to re-solder any of the wires or connectors of the ESC, be sure to use a soldering iron rated at least 60W to ensure a firm solder joint and to prevent damage to the ESC.
- Do not let the external temperature of the system exceed 90°C/194°F, high temperatures will damage the power system.
- After use, remember to disconnect the battery from the ESC. If the battery isn't disconnected, the ESC will continue to drain the battery, even if the ESC is turned off. The battery will eventually be completely discharged if let plugged in for long periods of time, thus resulting in battery failure and possible damage to the ESC. We are not responsible for any damage caused by this!

## Connections

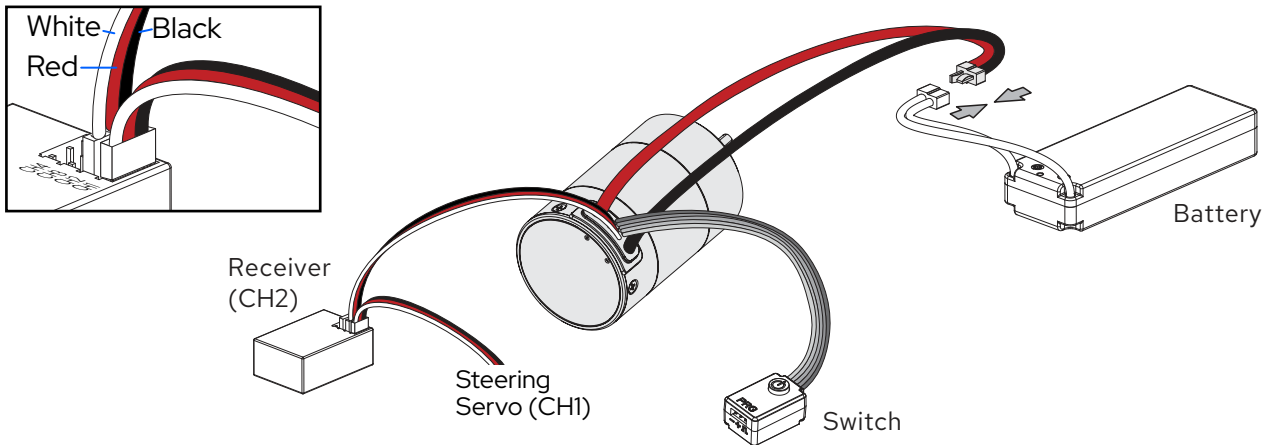

### • Connect the receiver:

Insert the ESC/motor's receiver cable into the throttle channel (CH2) of receiver. The red wire of the ESC/motor's receiver cable supplies 7.4V to the receiver so there is no need to provide the receiver with an additional power supply. Do not plug an additional power supply into the receiver, as it will damage the receiver. If you want to use an external BEC and power supply, you must first remove the red wire from the ESC/motor's receiver plug and wrap it with electrical tape or electrical shrink wrap to ensure it doesn't short out. If the inner metal of the red wire touches anything conductive, the ESC/motor will be damaged.

### • Connect the battery:

Plug in the battery as shown on page 1 of this manual. Be sure to line up the positive with positive and negative with negative polarities.

## Powering ON/OFF & LED Status Indicator

- Powering the ESC on and off: Short press the switch button to power on and long press the switch button to power off.
- ESC/Motor tones: Power on the ESC as stated above; the number of beeps emitted by motor indicates the number of LIPO Cells plugged into the ESC. Example: "Beep, Beep" indicates a 2S LIPO; "Beep, Beep, Beep" indicates a 3S LIPO. The last long tone "beep -" indicates that self-check is complete and the ESC can be run.
- Note: The power button also flashes in sequence with the motor's tones.

## Setting the ESC Throttle Range & Calibration

Release the ON/OFF button once the LED flashes.



1. Turn on the radio, adjust the "D / R", "EPA", "ATL" of the throttle channel to 100% (if the radio has no display screen, adjust the corresponding knob to the maximum position), and adjust the "TRIM" of the throttle channel to 0 (if the remote control has no display screen, adjust the corresponding knob to the middle position).
2. In power off state, press the power button and hold it continuously. The red light on the ESC's switch starts to flash, then release the power button immediately (If the power button is not released within 8 seconds, the ESC will enter other modes, and need to start over), the motor will sound synchronously.

Move the throttle trigger to the neutral position

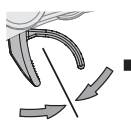

Press the ON/OFF button. The Green LED flashes once and the motor emits "Beep" tone.

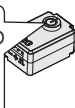

Pull the throttle trigger to the end position of forward.



Press the ON/OFF button. The Green LED flashes twice and the motor emits "Beep-Beep" tone.

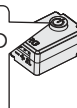

Push the throttle trigger to the end position of reverse.



Press the ON/OFF button. The Green LED flashes three times and motor emits "Beep-Beep-Beep" tone.



3. At this time, three points need to be set: the neutral position, the end position of forward and the end position of backward.
  - The throttle trigger stays at the neutral position, press the power button, the green light flashes once, and the motor emits "beep" once, indicating that the neutral position has been stored.
  - Move the throttle trigger to the end position of forward, press power button, the green light flashes twice, and the motor emits "beep" twice, indicating that the end position of forward has been stored.
  - Push the throttle trigger to the end position of backward, press power button, the green light flashes three times, and the motor emits "beep" three times, indicating that the end position of backward has been stored.
4. After calibrating, the motor can be operated normally.



## ESC Programmable Items

To set the programmable items, use the LED program box. The instructions can be found on the next page.

NOTE: The black shaded boxes in the following table are the default values of programmable items.

Item	Option 1	Option 2	Option 3	Option 4	Option 5	Option 6
1. Cutoff Voltage	Disabled	Low	Intermediate	High		
2. Motor Rotation	CCW	CW				
3. Drag Brake Force	Disabled	Level 1	Level 2	Level 3	Level 4	Level 5
4. Drag Brake Rate	Level 1	Level 2	Level 3	Level 4	Level 5	

- Cutoff Voltage:** This function is mainly to prevent the irrecoverable damage caused by over discharge of LIPO Cells. If the voltage protection is turned on, the ESC will monitor the battery voltage all the time during operation. Once the voltage is lower than the set threshold value, the power output will gradually reduce to 50% of the normal power within 3 seconds, and the power will completely cut off after about 40 seconds. When entering the low-voltage protection, the red LED will blink in the sequence of "▣—, ▣—, ▣—". When set to no protection, the ESC will not cut off power due to low voltage and is only intended for NiMH batteries. When using LIPO Cells, you must have the cutoff voltage turned on, otherwise the battery may be damaged due to over discharge. The low, medium and high options correspond to 3.0v/3.2v/3.4v respectively. For NiMH batteries, it is recommended to set this parameter to no protection.
- Motor Rotation:** When the motor shaft is facing the user and the throttle trigger is squeezed, like you would do to drive forward, the shaft turns clockwise when set to CW and counterclockwise when set to CCW. If the vehicle drives in reverse when you are giving it radio input to drive forward, you can change the motor rotation in the ESC. We recommend checking the radio's throttle reverse function first (see PG. 2).
- Drag Brake Force:** Drag brake represents an automatic braking force on the motor when the throttle trigger moves from a non-neutral position to the neutral position. There are 6 options of drag brake force to adjust, "Disabled" means the drag brake force is 0; the corresponding drag brake force increases from level 1 to level 5. Select the appropriate drag brake force according to you preference.
- Drag Brake Rate:** This controls how abruptly the drag brake force increases from zero to the set value when the radio trigger enters the neutral range, commonly called slow brake. This value has 5 options to adjust. The higher the level is, the more abruptly the drag brake reaches its full drag brake force value. Level 3 is recommended to can make the vehicle stop with more stability.
- RPM/Throttle Matching:** Permanently Enabled  
 When the resistance of the vehicle changes, the ESC will automatically adjust the amount of torque to adequately match the current speed, providing smooth and predictable performance.
- BEC Voltage:** 7.4V at 4A

## Setting ESC Parameters

To set the ESC parameters, use the LED program box. Connect the program box as shown below.

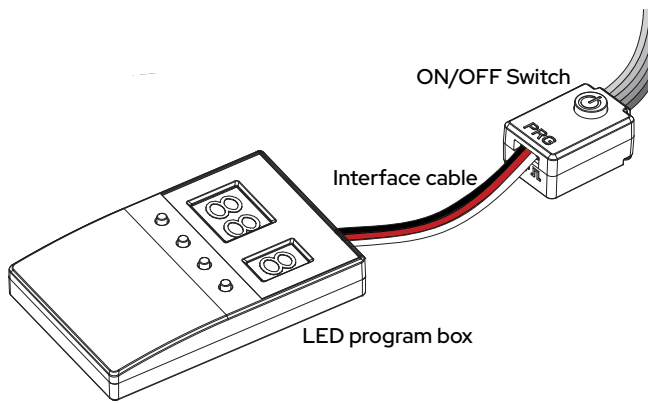

Using the LED program box to set ESC parameters.

With the ESC powered off, connect the 3-pin setting interface cable into the ESC's ON/OFF switch (PRG). Connect the other end of the cable into the program box, using the slot marked (100).

Power on the ESC.

After a few seconds, all ESC parameters can be displayed on the program box.

Use the "ITEM" button to select the item you wish to change and the "VALUE" button to select the option number of the value you wish to set. (See chart)

Press "OK" to save the new parameters to the ESC.

Remove the rubber dust plug from the "PRG" port on the ESC switch. Plug one end of the program cable into the switch, being sure the black wire is plugged into the (-) side of the "PRG" port.

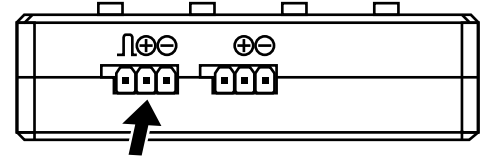
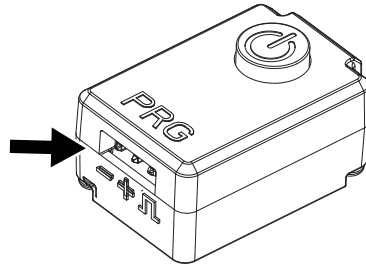

Use this port, on the program box to plug in the other end of the program cable. Be sure the black wire is plugged into the (-) side of the port.

## Factory Reset

Using the LED program box to restore factory settings.

After connecting the program box and the ESC, press the "RESET" button and then press the "OK" button.

## Automatic Motor Pairing

If the motor has been subjected to severe impact or has abnormal heating or power output during operation, do the following automatic motor pairing sequence below.

1. Disconnect the ESC from CH2 of the receiver and remove the motor's pinion gear.
2. Connect the battery, press and hold the ESC's ON/OFF button. The button will flash red first, then after 8 seconds flash green indicating the ESC is ready to start the automatic motor pairing process.
3. Release the ON/OFF button and the motor will automatically start rotating. Wait for the motor to stop rotating. The red light will flash, indicating that the automatic motor pairing process has been completed.
4. Power off the ESC and disconnect the battery.
5. Reconnect the ESC to CH2 of the receiver and reinstall the motor pinion gear to resume normal operation of the vehicle.

Note: Be sure to remove the motor gear before this operation, otherwise it may lead to incorrect pairing.

## Troubleshooting

TROUBLE	POSSIBLE CAUSE	POSSIBLE SOLUTIONS
The ESC will not power on.	<ol style="list-style-type: none"> <li>1. There isn't a battery plugged into the ESC.</li> <li>2. The LIPO battery being used isn't charged.</li> </ol>	<ol style="list-style-type: none"> <li>1. Plug a fully charged LIPO battery into the ESC and try again. (PG.1)</li> <li>2. Contact Redcat support.</li> </ol>
The vehicle ran backward when you pulled the throttle trigger towards you.	<ol style="list-style-type: none"> <li>1. The radio "Throttle Reverse" switch may be improperly set.</li> <li>2. The motor direction is set incorrectly.</li> </ol>	<ol style="list-style-type: none"> <li>1. Switch the radio "Throttle Reverse" switch. (PG.2)</li> <li>2. Be sure the motor direction is set correctly in the ESC. (PG.8-9. )</li> </ol>
Vehicle moves with no throttle input.	<ol style="list-style-type: none"> <li>1. Throttle trim is not set properly.</li> <li>2. The transmitter needs to be calibrated.</li> </ol>	<ol style="list-style-type: none"> <li>1. Set transmitter throttle trim. (PG.2)</li> <li>2. Calibrate the transmitter. (PG.7)</li> </ol>
The motor suddenly stops working.	<ol style="list-style-type: none"> <li>1. Transmitter signal is lost</li> <li>2. The battery pack needs charging or the thermal protection may have been activated.</li> </ol>	<ol style="list-style-type: none"> <li>1. Be sure the transmitter has good batteries and is turned on.</li> <li>2. Check the battery voltage and the ESC temperature. Let cool and recharge battery. (PG.9)</li> </ol>
Power on and finish inspecting the number of LIPO cells (Green light flashes N times), red light flashes quickly.	<ol style="list-style-type: none"> <li>1. Throttle signal is not detected by the ESC;</li> <li>2. The neutral position of ESC and radio is unmatched.</li> </ol>	<ol style="list-style-type: none"> <li>1. Check that the ESC is plugged into the receiver (CH2) correctly and that the radio is turned on.</li> <li>2. Be sure the throttle is in neutral position. Recalibrate the throttle range on the ESC.</li> </ol>
The indicator light is not on after powering on the ESC, but the motor is irresponsive.	<ol style="list-style-type: none"> <li>1. The battery voltage is not received by the ESC.</li> <li>2. The ESC's switch is damaged.</li> </ol>	<ol style="list-style-type: none"> <li>1. Be sure there's a good connection between the battery and the ESC.</li> <li>2. Be sure the battery is charged and undamaged.</li> <li>3. Replace the switch.</li> </ol>
Clicking noise while steering.	<ol style="list-style-type: none"> <li>1. The servo horn is stripped.</li> <li>2. The servo gears are stripped.</li> </ol>	<ol style="list-style-type: none"> <li>1. Replace the servo horn.</li> <li>2. Replace the servo.</li> </ol>
Vehicle won't steer or move.	<ol style="list-style-type: none"> <li>1. Battery pack not charged.</li> <li>2. Battery wires loose.</li> <li>3. Did not follow proper start-up instructions.</li> </ol>	<ol style="list-style-type: none"> <li>1. Charge the battery pack.</li> <li>2. Plug in the battery securely.</li> <li>3. Follow the start-up sequence on PG.1.</li> </ol>
Vehicle turns to the side automatically.	<ol style="list-style-type: none"> <li>1. Steering trim needs adjusting.</li> <li>2. Steering servo horn needs realigning or replaced.</li> <li>3. Servo gears are stripped.</li> </ol>	<ol style="list-style-type: none"> <li>1. Adjust transmitter steering trim. (PG.2)</li> <li>2. Check servo horn, replace if worn or stripped.</li> <li>3. Replace the servo.</li> </ol>
Vehicle steers to the left when you steer to the right.	<ol style="list-style-type: none"> <li>1. Steering reverse (on transmitter) is set incorrectly.</li> <li>2. You are driving towards yourself and it just seems like it's backwards.</li> </ol>	<ol style="list-style-type: none"> <li>1. Set the steering reverse on transmitter. (PG.2)</li> <li>2. Practice driving the vehicle to get used to steering with different vehicle orientations. When driving towards yourself, it just seems like the steering is backwards.</li> </ol>

# CHANGING THE UNDERDRIVE GEARS - EVEREST ASCENT & ASCENT FUSION

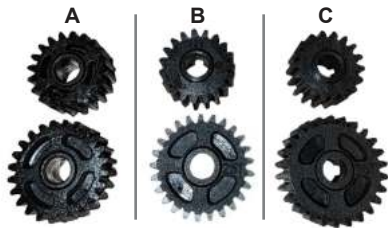

## Gearing Options:

- A: 0% Underdrive - 20T upper and 24T lower. (NO markings on gears)
- B: 10% Underdrive (9.2% Actual) - 19T upper 25T lower. (Gears are marked)
- C: 20% Underdrive (18.49% Actual) - 18T upper 26T lower. (Gears are marked)

**ATTENTION:** You must use one of the combinations shown above. Other combinations will not work due to fitment and gearmesh issues.

**Stock Gearing:** Everest Ascent - 0% Underdrive  
Ascent Fusion - 20% Underdrive

**1.** Unbolt the top of one of the rear shocks.



**2.** Unbolt rear driveshaft from the transfercase.



**3.** Remove driveshaft from the transfer case.

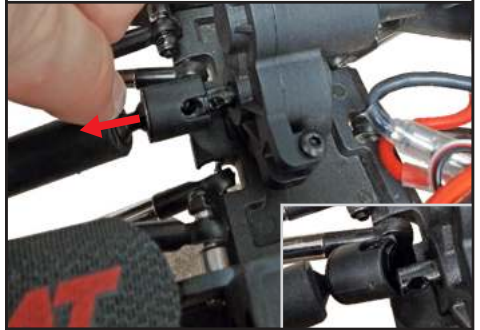

**4.** Unscrew the 2 screws on the top of the transfer case.

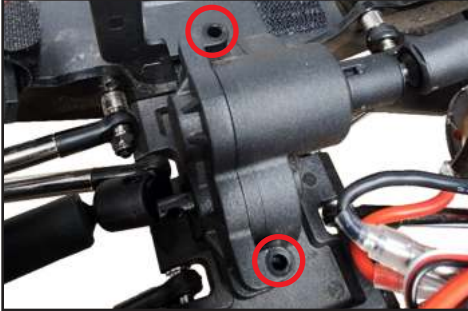

**5.** Pull the rear cover off of the transfer case.



**6.** Angle the front of the chassis down and pull the upper gear out of transfer case. (Angling the chassis helps to keep the gear pin from falling out of the idler shaft.)

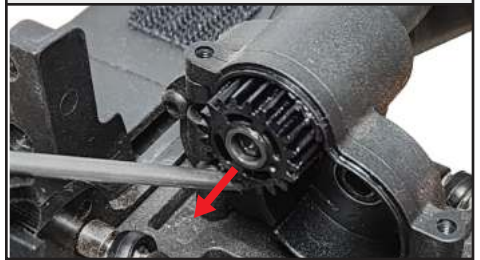

This is what it should look like.



**7.** Push the lower idler shaft out of rear case.

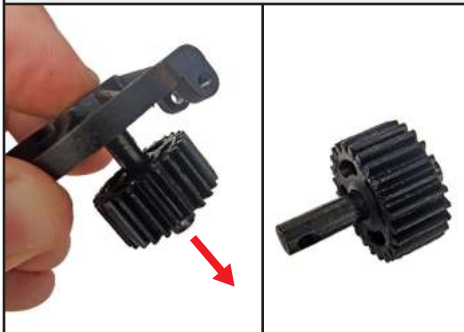

**8.** Pull the gear off of the lower idler shaft.

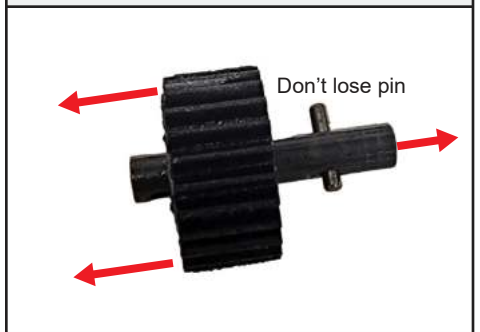

**9.** Choose an underdrive gear set:  
0% - 20T upper / 24T lower. (no markings)  
10% (9.2% Actual) - 19T upper / 25T lower.  
20% (18.49% Actual) - 18T upper / 26T lower.

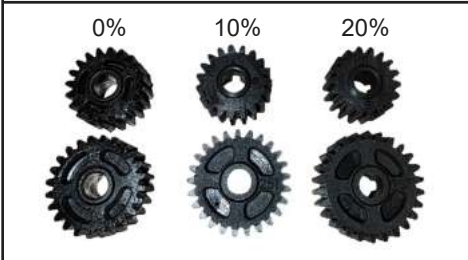

**10.** Put the new lower gear on lower idler shaft. (Will be either 24T, 25T, or 26T depending on your choice) (see step 9)

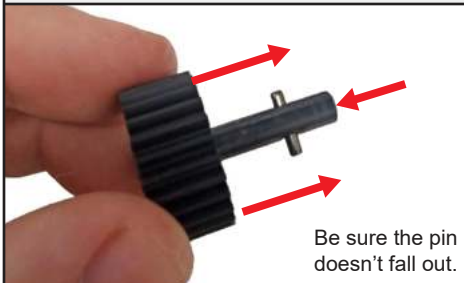

**11.** Put the lower idler shaft into the rear case.

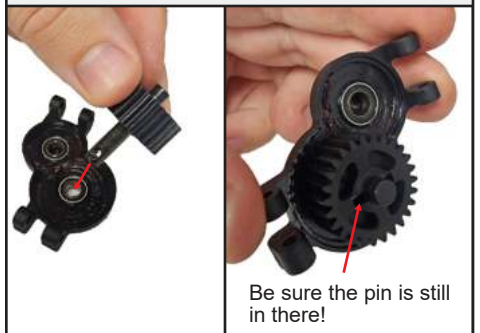

## CHANGING THE UNDERDRIVE GEARS - EVEREST ASCENT & ASCENT FUSION

**12.** Slide the new upper gear onto the upper idler shaft. (Will be either 20T, 19T, or 18T depending on choice) (18T is pictured)



**13.** Realign the rear case and gently push it into place. (you may need to rotate the idler shaft slightly to line up the gears)



**14.** Reinstall the two screws. The longer screw goes into the driver's side of the case and the shorter screw goes into the passenger's side.

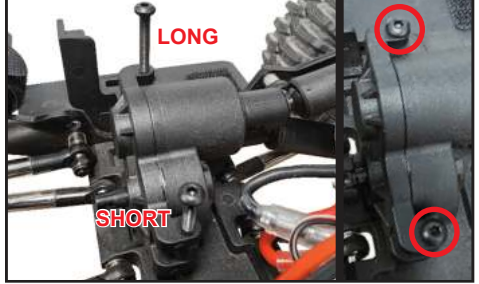



































**15.** Reattach the driveshaft and reinstall the driveshaft screw.



**16.** Reconnect the rear shock.

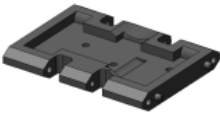











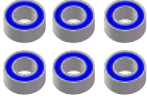

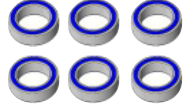

















# SPARE PARTS

<p>RER30681-F/R Bumper (Aluminum)(1pc)</p> 	<p>RER30682-Front Shocks (Aluminum)(1pr)</p> 	<p>RER30683-Rear Shocks (Aluminum)(1pr)</p> 	<p>RER30684- Portal Outer Cover (Brass)(52g)(Black) (1pr)</p> 	<p>RER30685-Differential Cover (Aluminum)(Red) (1pc)</p> 
<p>RER30686-Body Post (Aluminum)(Black)(2pcs)</p> 	<p>RER30781-3mm Counter-sunk Washer (Aluminum) (Red)(12pcs)</p> 	<p>RER30782-Carbon Fiber Frame Rails (1set)</p> 	<p>RER30783-Carbon Fiber Motor Plate (1pc)</p> 	
<p>RER30784-Carbon Fiber Shock Tower (2pcs)</p> 	<p>RER30785-10T Pinion Gear (32P)(1pc)</p>  <p>3*3</p>	<p>RER30786-67mm Link (Aluminum)(Black)(6pcs)</p> 	<p>RER30787-73mm Link (Aluminum)(Black)(6pcs)</p> 	<p>RER30788-Pre-Mounted MT-9 Mud Terrain Tire on Beadlock Wheels (1pr)</p> 
<p>RER15430-Decorative Bead Lock Rings(4pcs)</p> 	<p>RER12107 Beadlock Wheels No Rings (Black)(Plastic)(2pcs)</p> 	<p>13813-Beadlock Rings (2 pairs)</p> 	<p>RER31203 Front Upper Links (64.5mm)(Black) (2pcs)</p> 	<p>RER31204 Rear Upper Links (94mm)(Black) (2pcs)</p> 
<p>RER30789-Front Lower Links (83mm)(Black) (Aluminum)(2pcs)</p> 	<p>RER30790-Rear Lower Links (96mm)(Black) (Aluminum)(2pcs)</p> 	<p>RER30791-Servo Link (44.5mm)(Black)(1pc)</p> 	<p>RER30792-Steering Link (96mm)(Black)(1pc)</p> 	<p>RER30793-Panhard Bar (84.4mm)(Black)(1pc)</p> 
<p>RER22341-MT-9 Mud Terrain 1.9 Tires (Soft)(1pr)</p> 	<p>RER22041-Body Post Set (1Set)</p> 	<p>RER22042-Servo Mount Set (1Set)</p> 	<p>RER22043-Battery Tray Set (1Set)</p> 	<p>RER22138-Side Plates(1pr)</p> 
<p>RER22139-Shock Towers (Rear)(1pc)</p> 	<p>RER22140-Center Skid Plate(1pc)</p> 	<p>RER22653 Center Transfer Case Complete w/ Skid(1pc)</p> 	<p>RER22141-Fr Body Mount Hinge Set (1set)</p> 	<p>RER22142-Motor Plate Mounts(1set)</p> 

# SPARE PARTS

<p>RER22143-Transmission Housing set(1set)</p> 	<p>RER22145-56T Spur Gear (32P)(1pc)</p> 	<p>RER22240-Transfer Case Gear (20T)(2pcs)</p> 	<p>RER22241-Transfer Case Gear (24T)(2pcs)</p> 	<p>RER22242-Transfer Case Gear Option Set (18T/19T/25T/26T)(1set)</p> 
<p>RER22243-Front Center Driveshaft(29mm)(1set)</p> 	<p>RER22244-Rear Center Driveshaft(37mm)(1set)</p> 	<p>RER22245 Transfer Case Driveshaft Set(1set)</p> 	<p>RER22039-F/R Bumper Set w/Mounts(Stand)(1Set)</p> 	<p>RER22040-F/R Bumper Set w/Mounts(Dovetail)(1Set)</p> 
<p>RER15431-Lower Link Mounts(1set)</p> 	<p>RER15432-Portal Center Gearbox Housing(2pcs)</p> 	<p>RER15429-Front Portal Housing Set (1set)</p> 	<p>RER11816-Rear Outer Portal Housing Set (L/R)</p> 	<p>180016S Aluminum Wheel Hex &amp; Pin (4pcs ea.)</p> 
<p>RER11347-Portal Axle Spool (1pc)</p> 	<p>RER11362-Portal Axle Ring Gear(32T)(2PCS)</p> 	<p>RER11363-Portal Axle Pinion Gear(11T)(2pcs)</p> 	<p>RER11364-Portal Axle Output Gear(17T)(2pcs)</p> 	<p>RER11365-Rear Portal Axle Input Gear(8T)(2pcs)</p> 
<p>RER11356-Metal Slipper Plate(2pcs)</p> 	<p>RER11357-Slipper Pads (2pcs)</p> 	<p>RER11349-Rear Portal Axle Shafts</p> 	<p>RER15439-Front Portal Universal Shafts(1pr)</p> 	<p>RER11420-Shaft for 17T Gear (2pcs)</p> 
<p>RER11421-Shaft for 11T Gear (2pcs)</p> 	<p>RER21669-Universal Axle Rebuild Kit (1set)</p> 	<p>RER22345-Transfer Case Shaft for 20T Gear(1pc)</p> 	<p>RER22442-Transfer Case Shaft for 24T Gear (2pcs)</p> 	<p>RER22346-Top Shaft for 56T Gear(1pc)</p> 
<p>70544- Ball Head Of Front Shock (5MM)</p> 	<p>18052-Short Rod End Ball (5.8mm)(8pcs)</p> 	<p>70625-Ball Stand Ø5.9 (Long) (6pcs)</p> 	<p>RER11371-4*8*3mm Rubber Sealed Ball Bearings(6pcs)</p> 	<p>RER11370-6*10*3mm Rubber Sealed Ball Bearings(2pcs)</p> 

# SPARE PARTS

<p>RER11373-10*5*4mm Rubber Sealed Ball Bearings(6pcs)</p> 	<p>RER11368-6*12*4mm Rubber Sealed Ball Bearings(6pcs)</p> 	<p>RER11369-7*11*3mm Rubber Sealed Ball Bearings(2pcs)</p> 	<p>RER11372-15*10*4mm Rubber Sealed Ball Bearings(6pcs)</p> 	<p>RER11367-12*18*4mm Rubber Sealed Ball Bearings(2pcs)</p> 
<p>RER11374-2*4mm Button Head Hex Machine Thread Screws (10pcs)</p> 	<p>82045-3*8mm Button Head Hex Machine Thread Screws (10pcs)</p> 	<p>50100-3*10mm Button Head Hex Machine Thread Screws (8pcs)</p> 	<p>50101-3*12mm Button Head Hex Machine Thread Screws (12pcs)</p> 	<p>14582-3*14mm Button Head Hex Machine Thread Screws (10pcs)</p> 
<p>RER11376-3*16mm Button Head Hex Screw (10pcs)</p> 	<p>82047-3*20mm Button Head Hex Machine Thread Screws (8pcs)</p> 	<p>70581-3*23mm Button Head Hex Machine Thread Screws (8pcs)</p> 	<p>13854-3*28mm Button Head Hex Machine Thread Screws (8pcs)</p> 	<p>BS702-036 3*35mm Shoulder Button Head Hex Machine Thread Screws (12pcs)</p> 
<p>RER11377-3*43mm Shoulder Button Head Hex Machine Thread Screws (10pcs)</p> 	<p>RER11378-2*6mm Cap Head Hex Machine Thread Screw (10pcs)</p> 	<p>13834-Round Head 2*8 Tapper Hex Screw 12p</p> 	<p>RER11381-2*14mm Cap Head Screw (10pcs)</p> 	<p>RER11382-2*8mm Countersunk Hex Machine Thread Screws(10pcs)</p> 
<p>85825-3*10mm Countersunk Hex Machine Thread Screws(4pcs)</p> 	<p>14577-3*12mm Countersunk Hex Machine Thread Screws(10pcs)</p> 	<p>BS502-030 3x14mm Countersunk Hex Machine Thread Screws (12pcs)</p> 	<p>13840-3*18mm Hex Screw (8pcs)</p> 	<p>RER15452-4*11.5mm Hex Screw Pin(10pcs)</p> 
<p>08027-Pin 2*10mm</p> 	<p>116201-2*10.8mm Pin (10pcs)</p> 	<p>02102-3mm Lock Nuts (6pcs)</p> 	<p>RER11384-King Pin Bushing(8pcs)</p> 	<p>RER12694 4mm Serrated Nylon Lock Nut (6pcs)</p> 
<p>RER13469-R- Clip(Black)</p> 	<p>RER11426-Shim 4.2*8*0.4(10pcs)</p> 			



## SPARE BODY PARTS

<p>RER30794-10th Crawler Cab Only Body (Black)(1pc)</p> 			
---	--	--	--

## ELECTRONICS

<p>RER12089-Servo Arm (metal)</p> 	<p>RER11385-Battery Straps (250mm)(2pcs)</p> 	<p>RER28551-Fusion 2in1 ESC/Motor (Brushless) (1pc)</p> 	<p>RER16244 - HEXFLY Torque Spec Metal Gear Servo (Waterproof) (1pc)</p> 	

## OPTIONAL PARTS

<p>RER30581-Motor Plate Mount (Aluminum) (Red)(1set)</p> 	<p>RER30582-Motor Plate Mount (Aluminum) (Bronze)(1set)</p> 	<p>RER30583-Panhard Mount (Aluminum)(Red)(1pc)</p> 	<p>RER30584-Panhard Mount (Aluminum)(Bronze)(1pc)</p> 	<p>RER30585-Diff Cover (Brass)(Black)(1pc)</p> 
<p>RER30586-Portal Outer Cover (Brass)(Black) (1pr) 73g</p> 				

# FRONT SHOCKS AND AXLE EXPLODED VIEW

Front

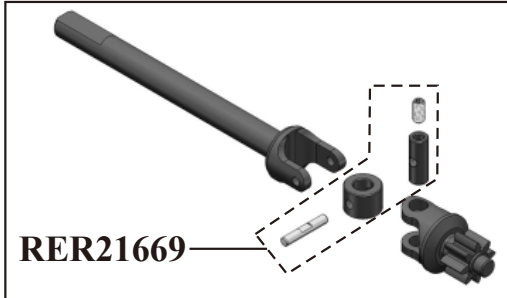
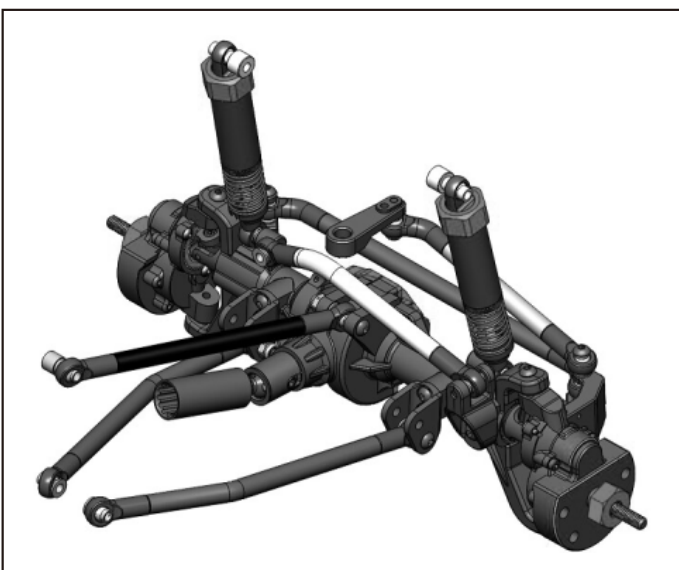
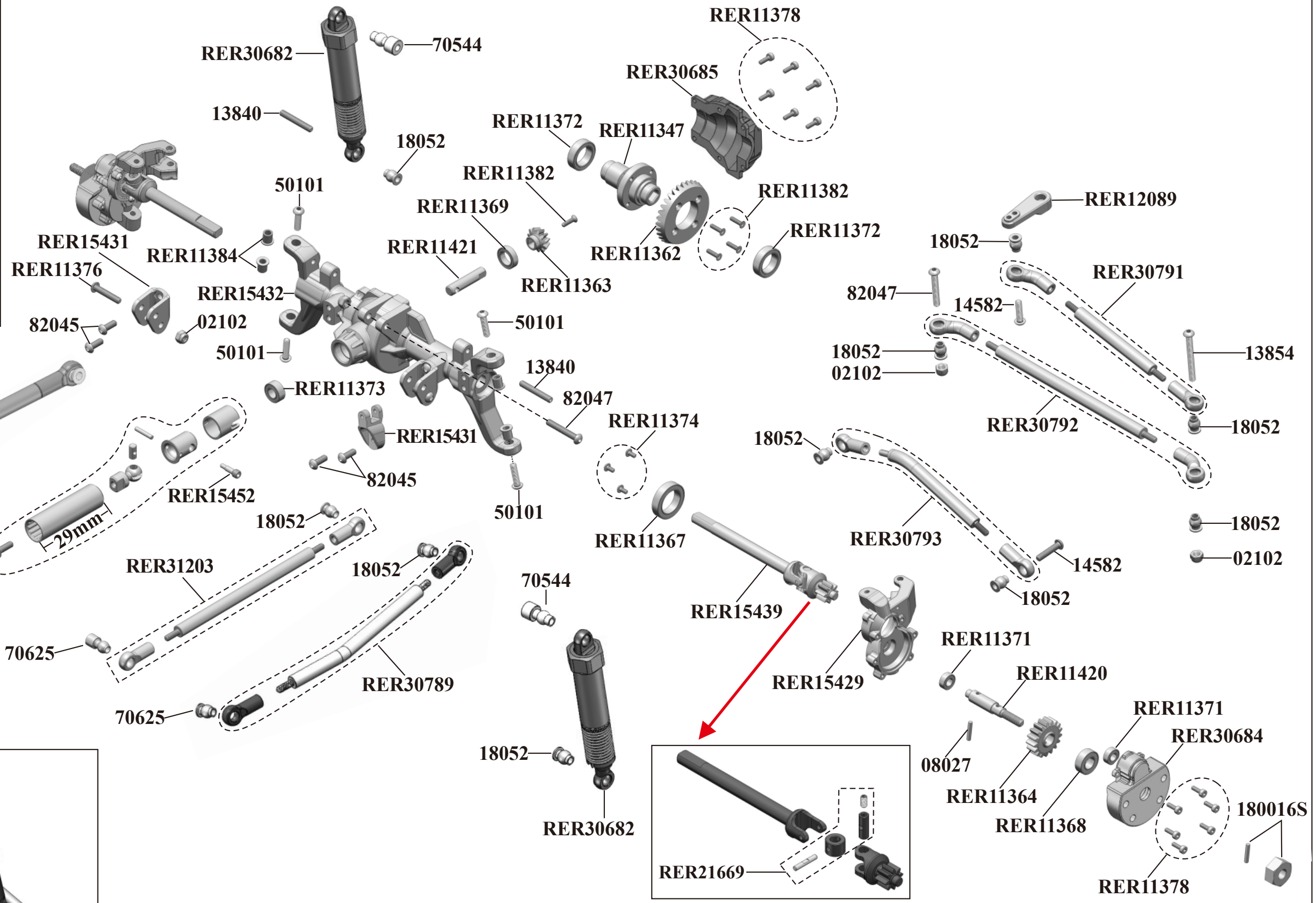
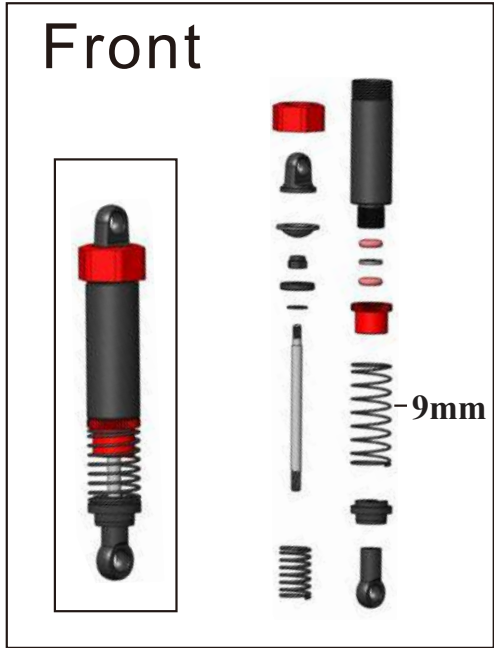

# REAR SHOCKS AND AXLE EXPLODED VIEW

Rear

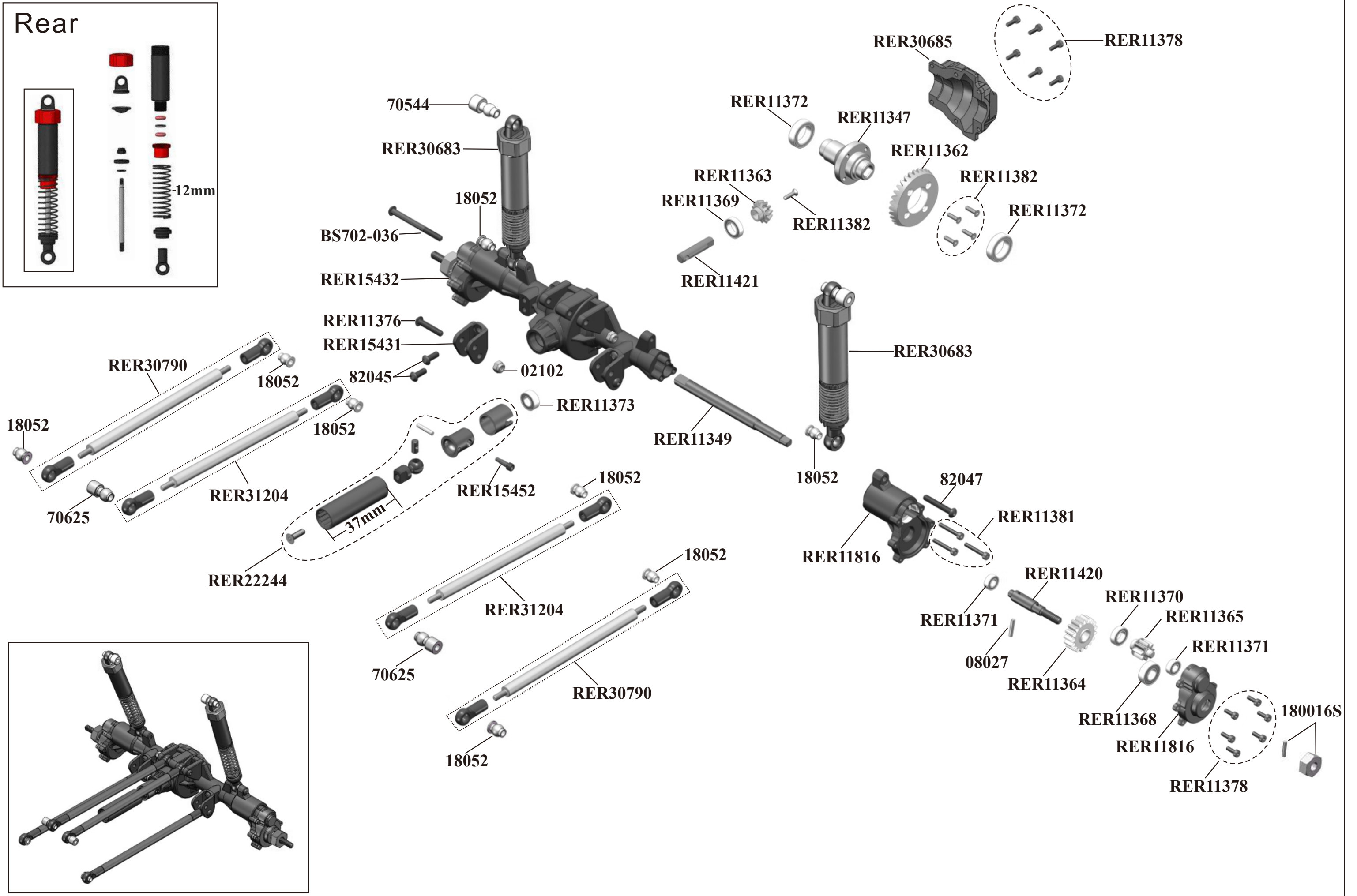
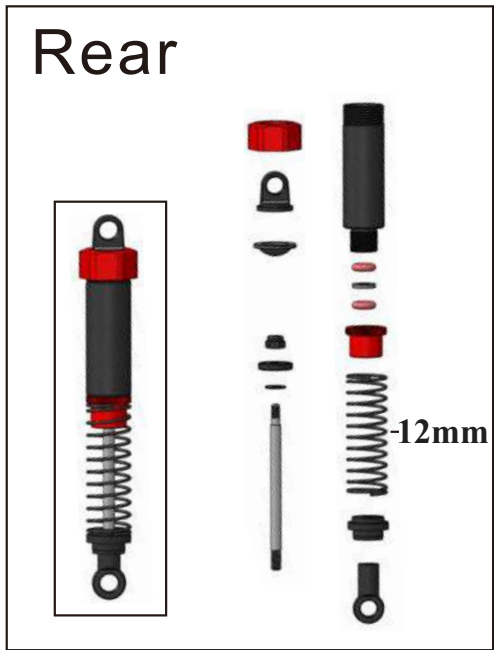

# MOTOR AND TRANSFER CASE ASSEMBLY EXPLODED VIEWS

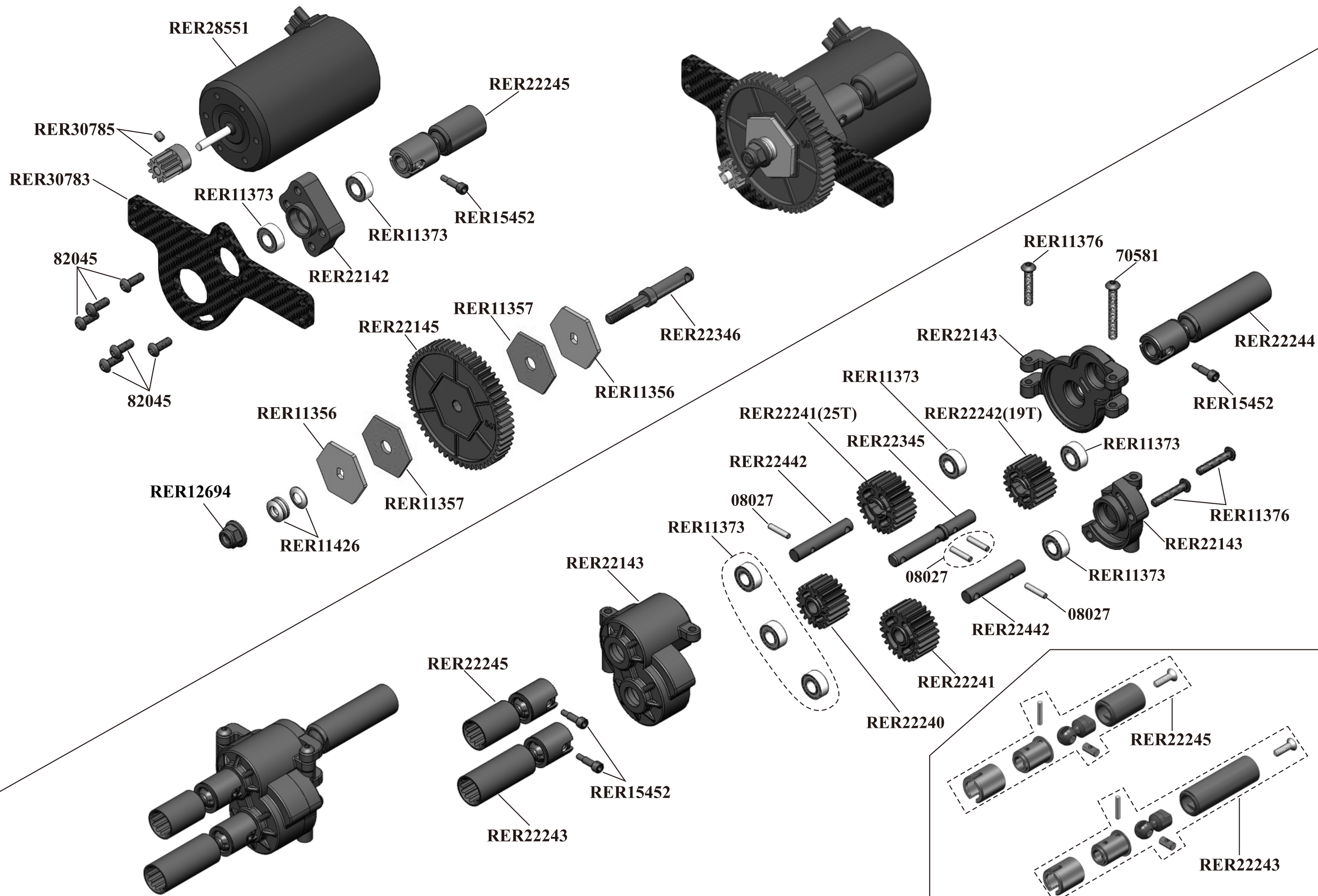

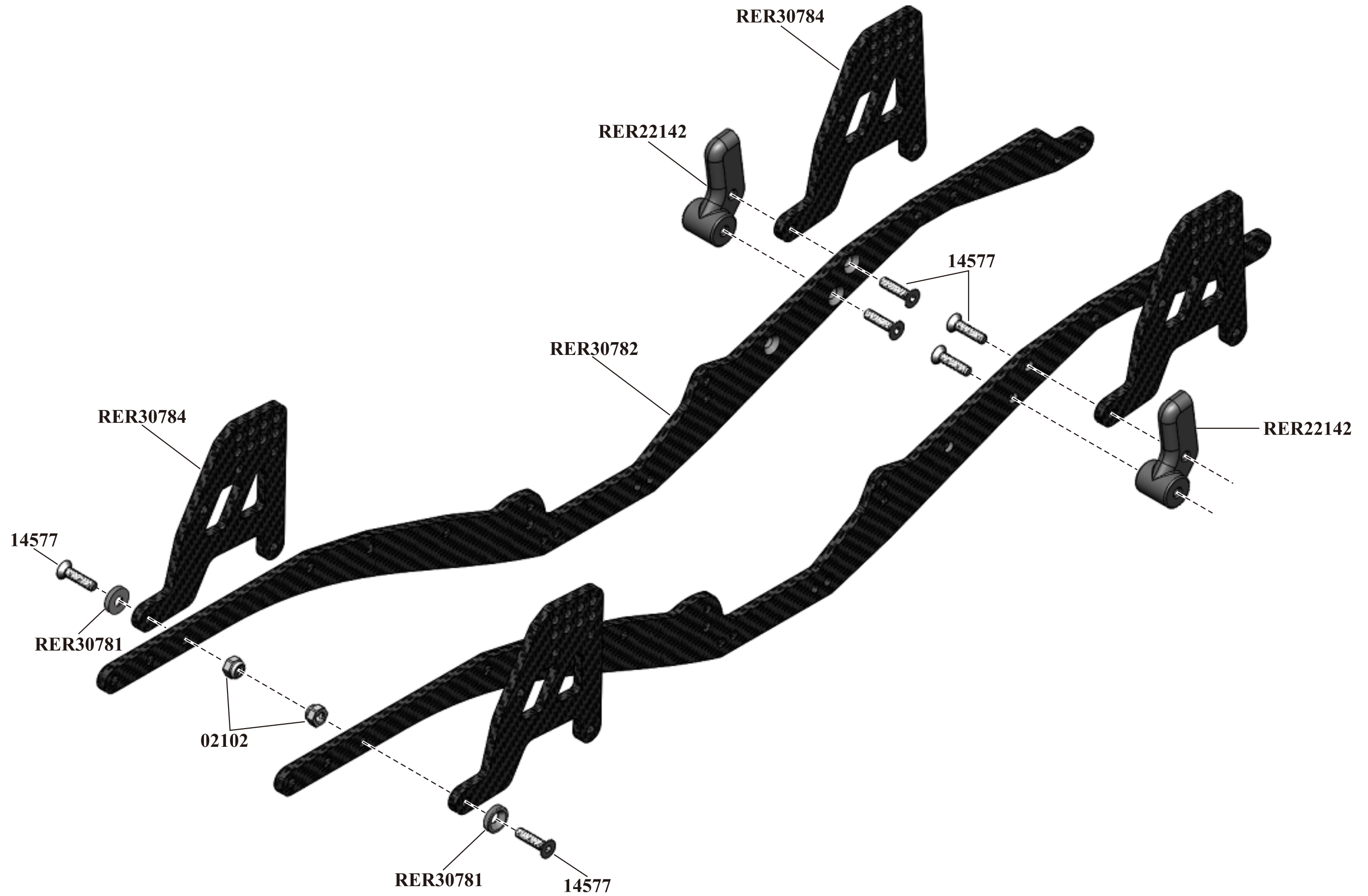

# CHASSIS ASSEMBLY

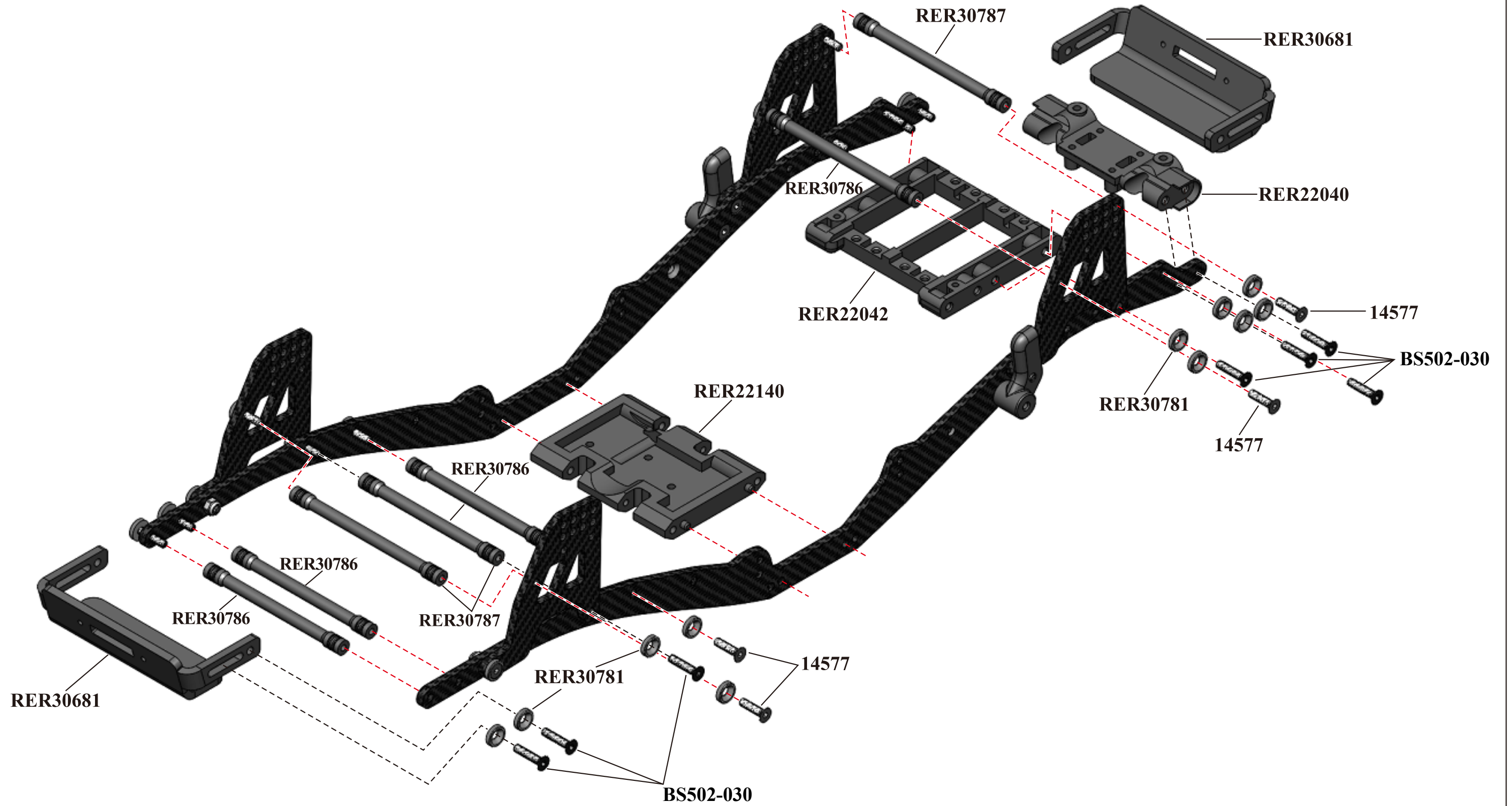

# MOTOR ASSEMBLY INSTALLATION

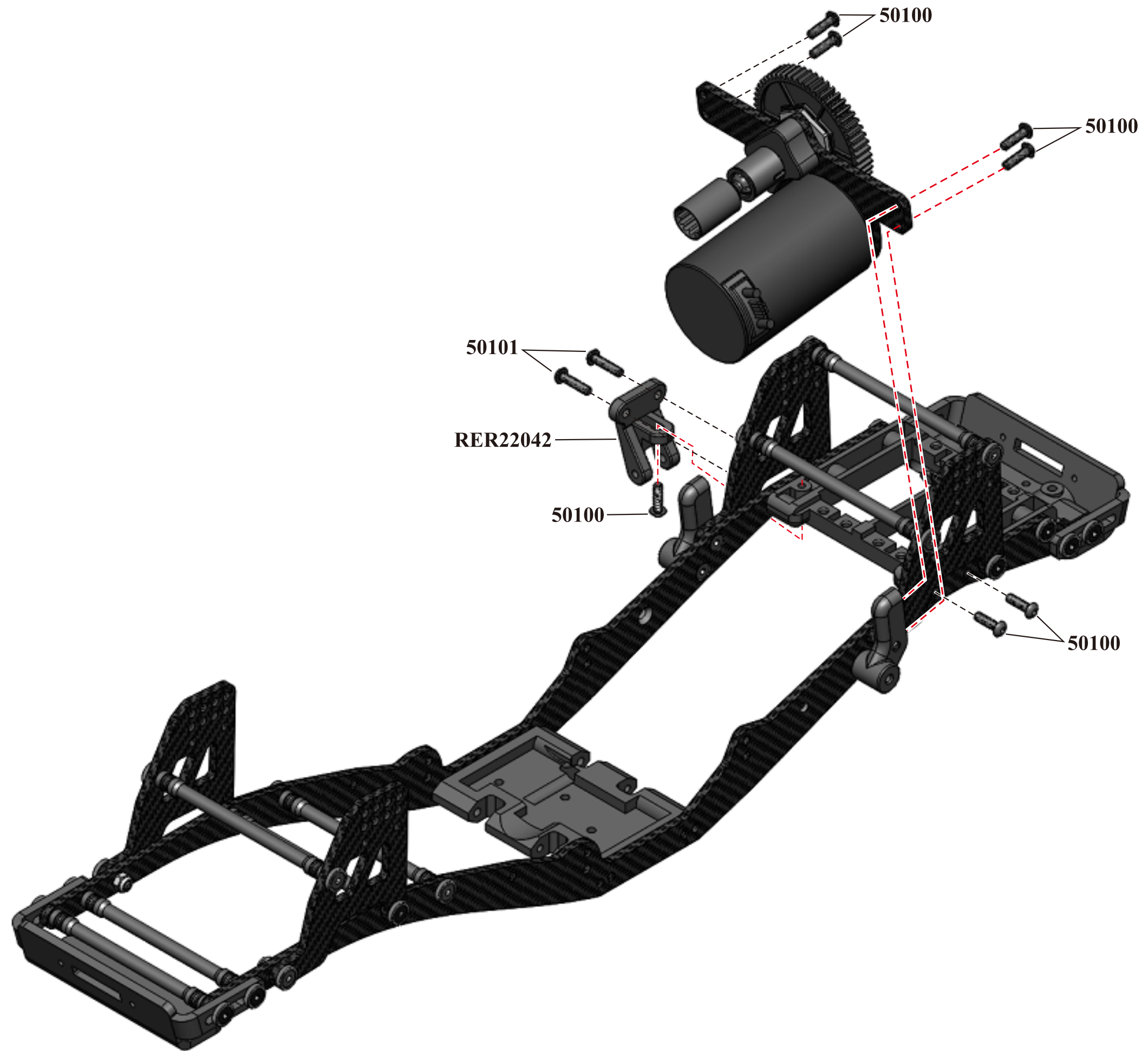

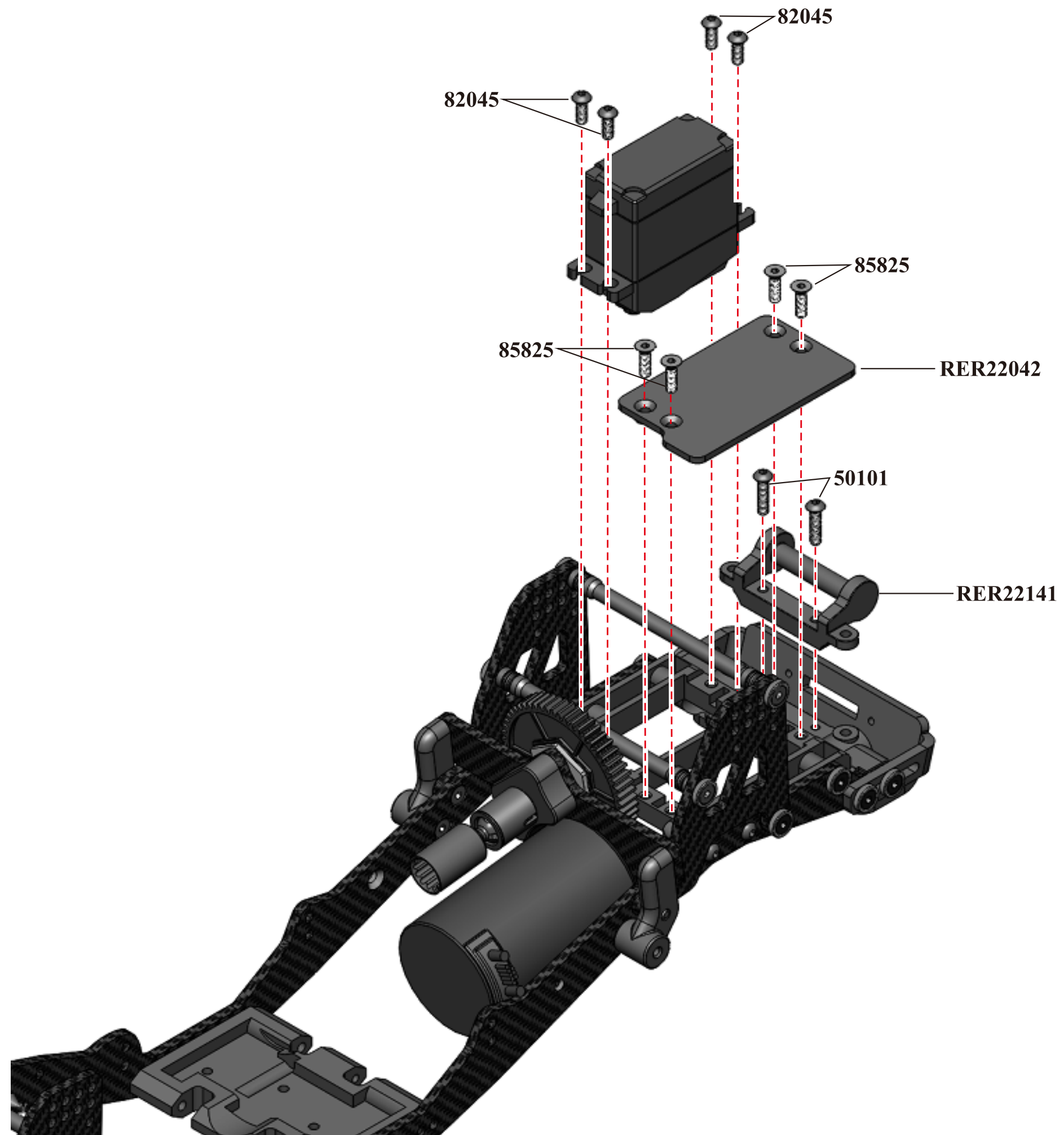



# TRANSFER CASE INSTALLATION

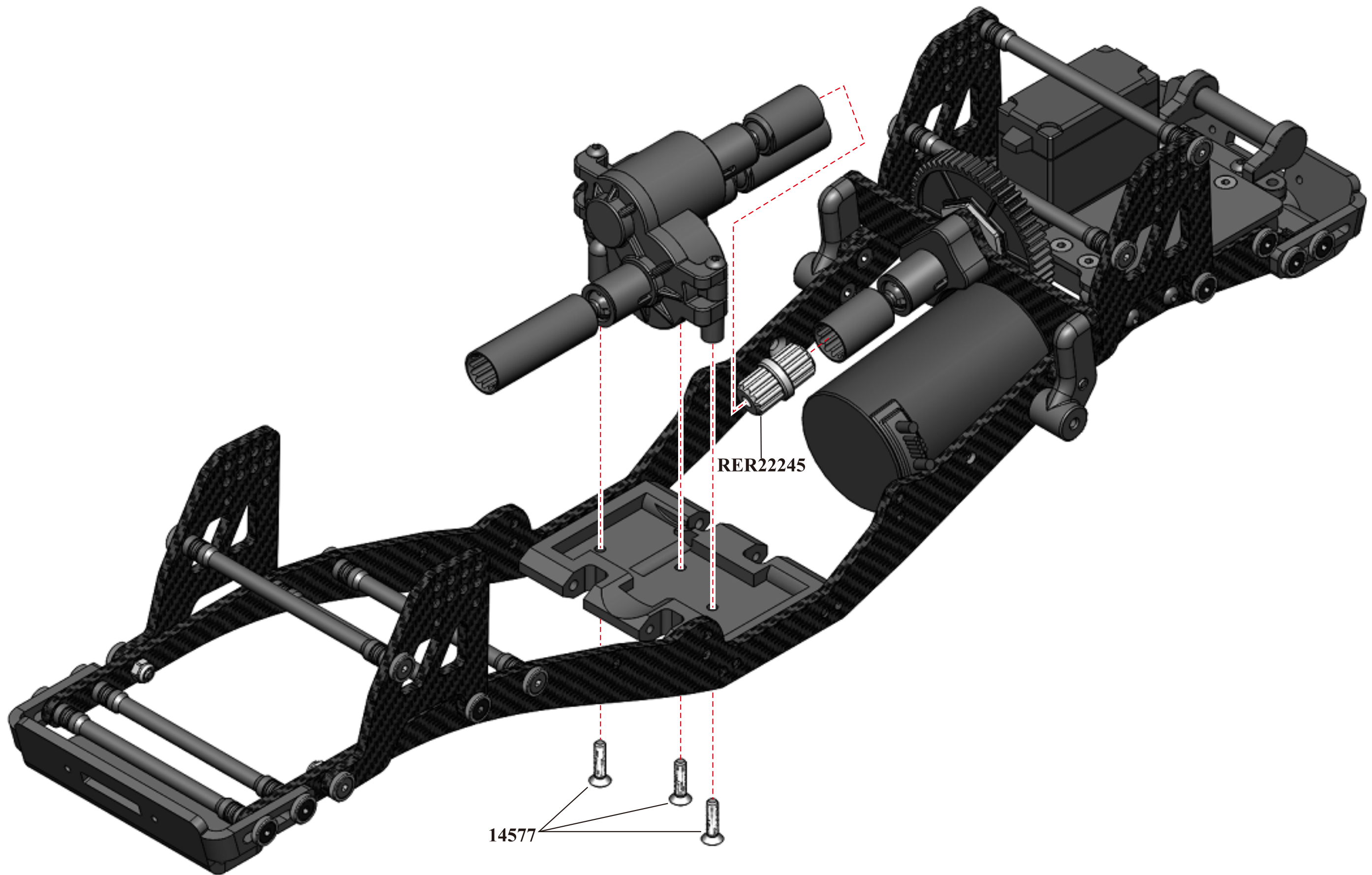

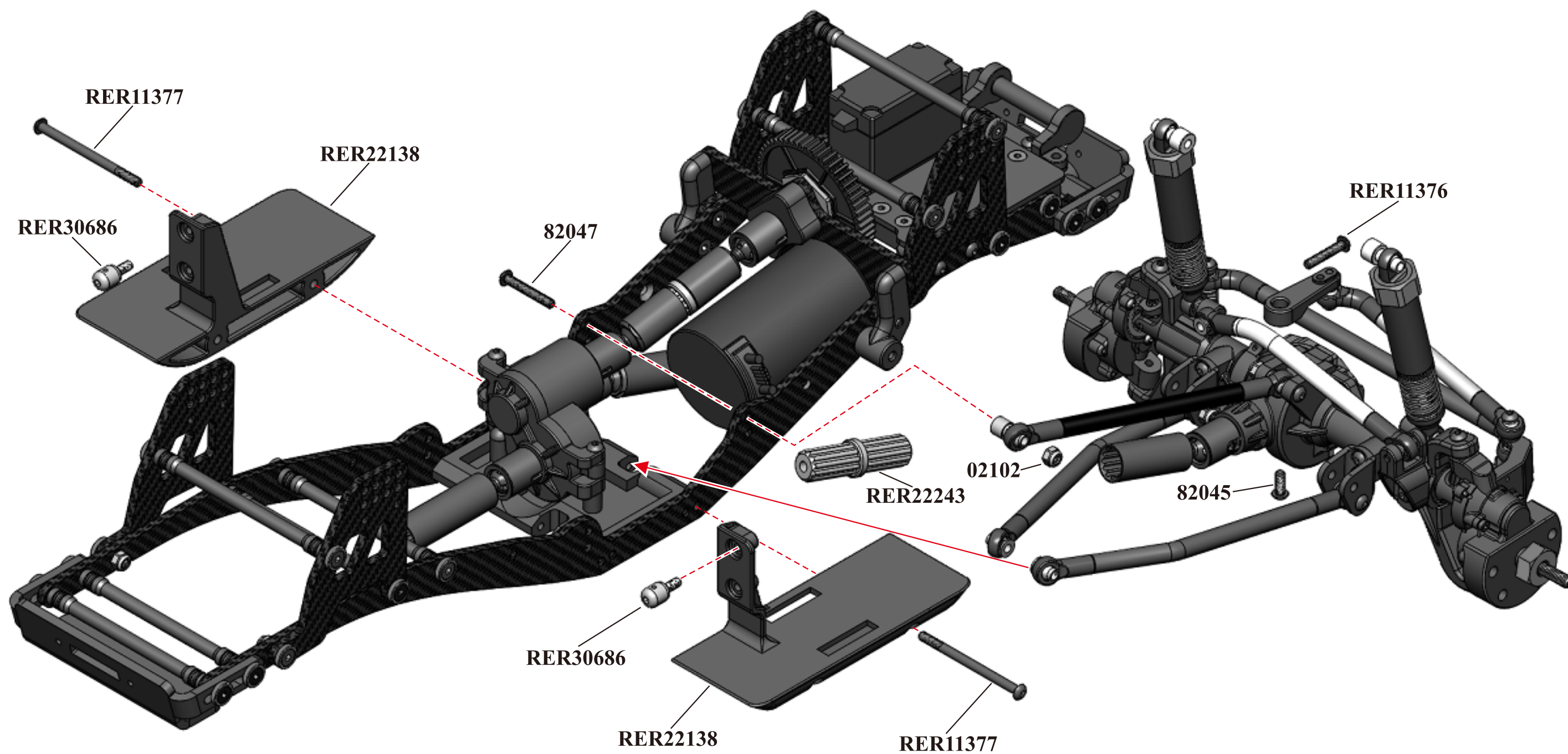

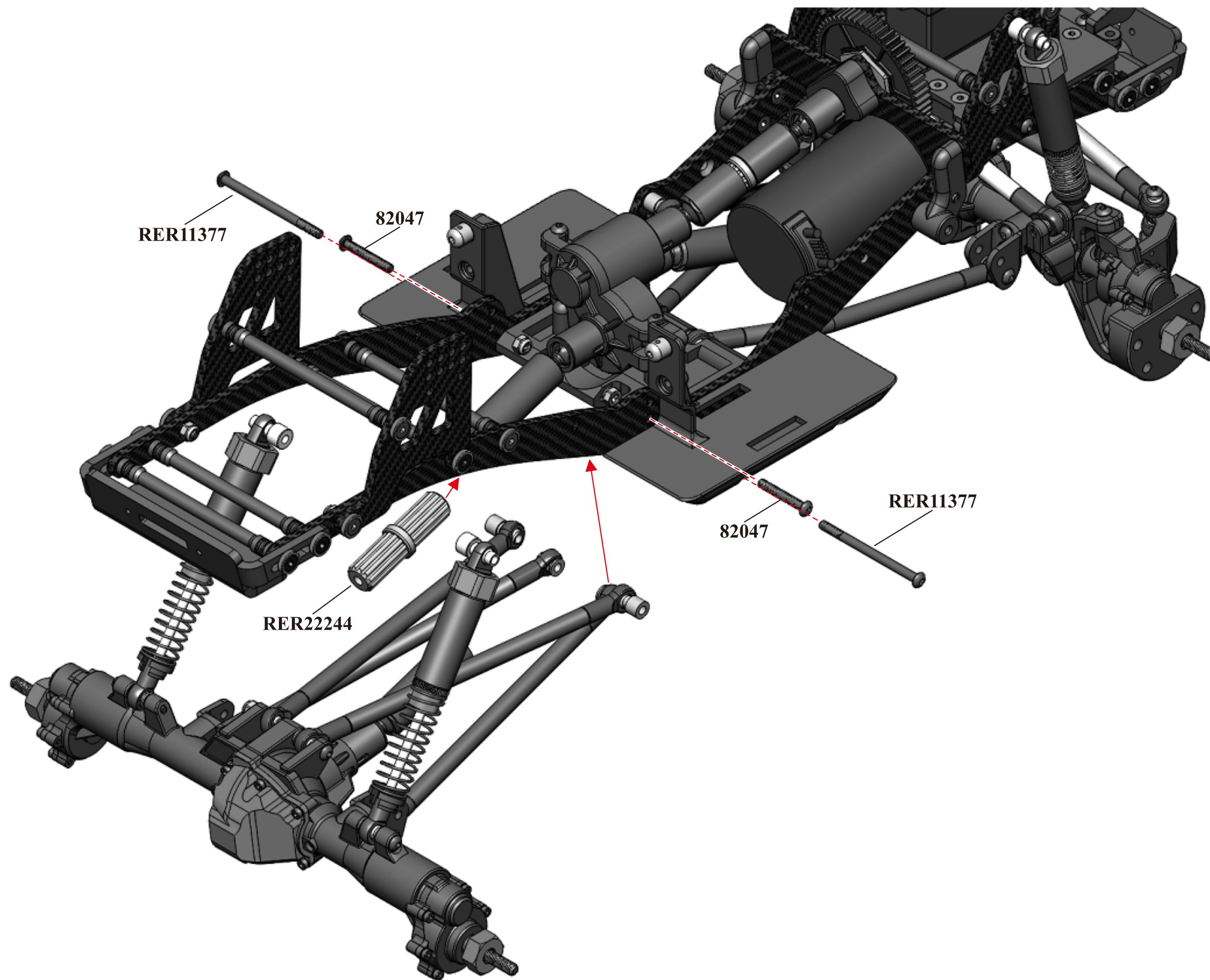

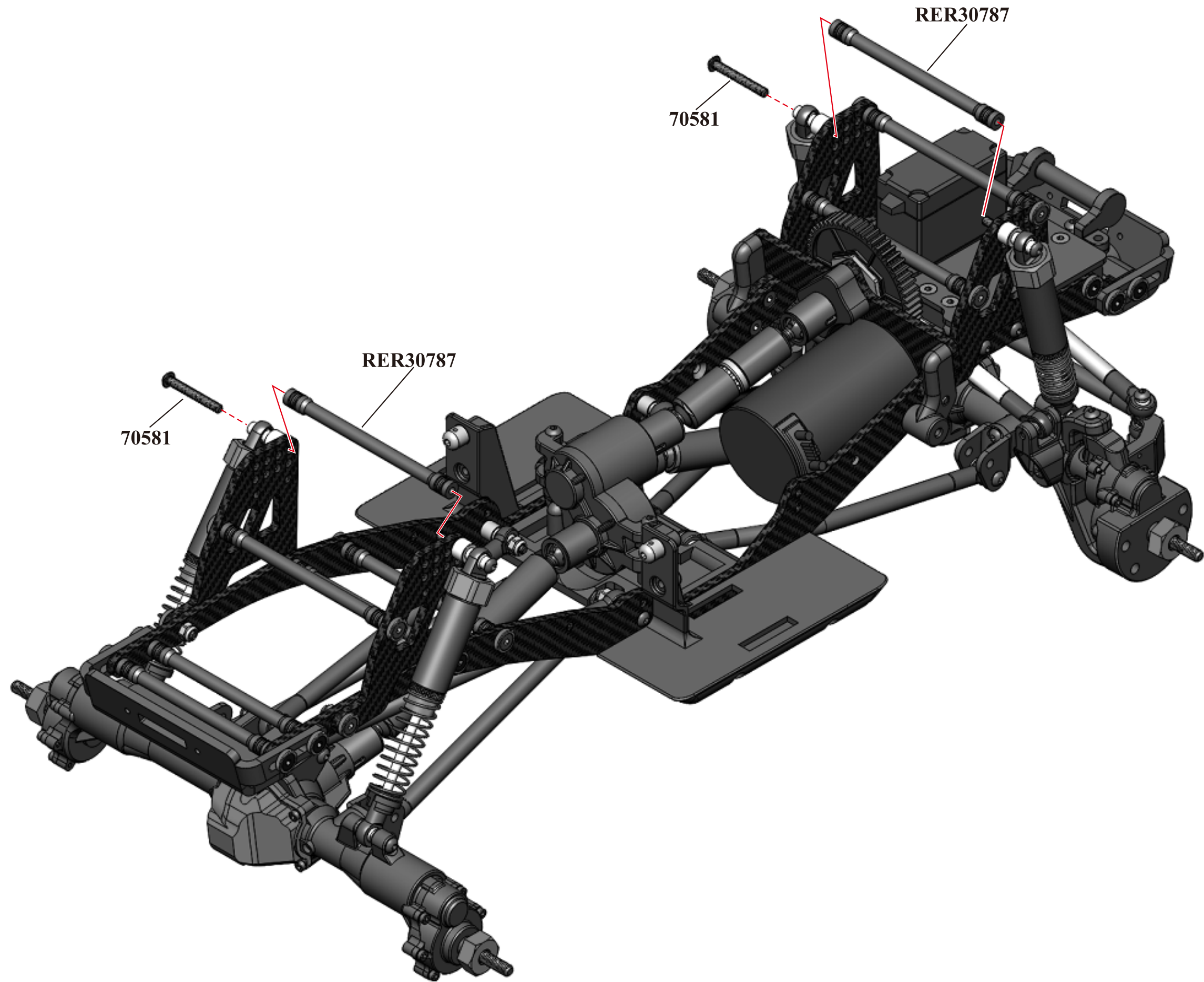

Left

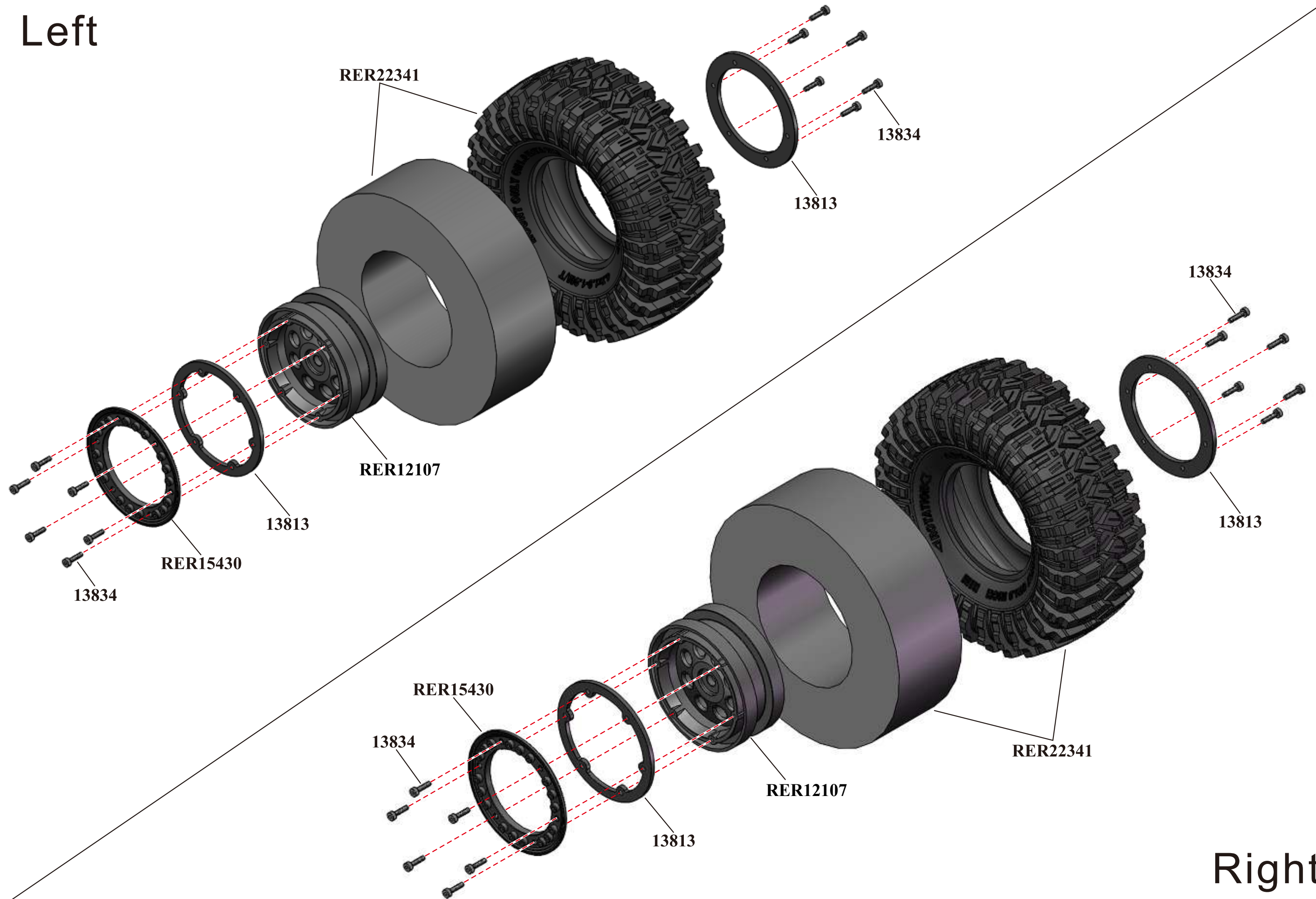

Right

# WHEEL INSTALLATION

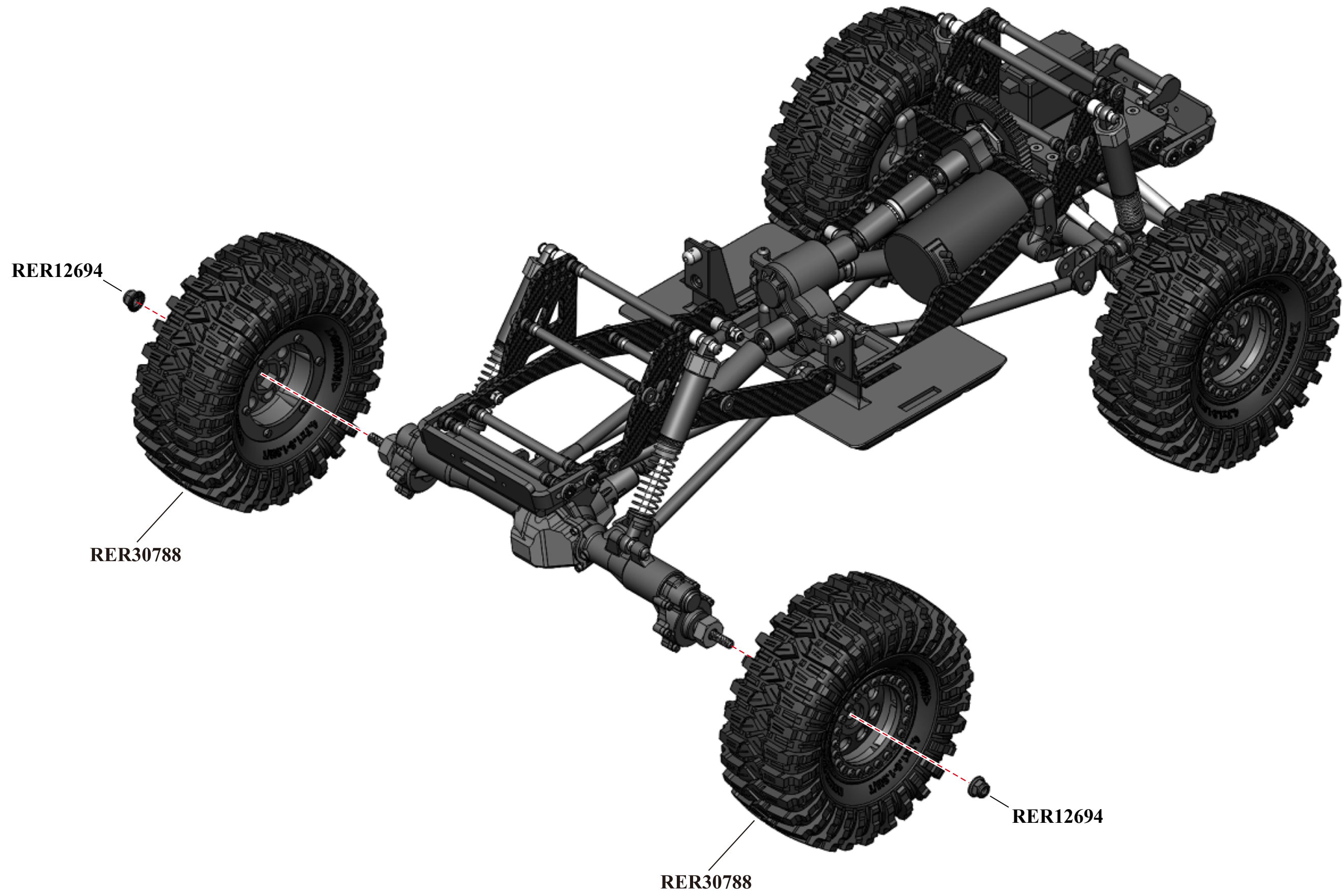

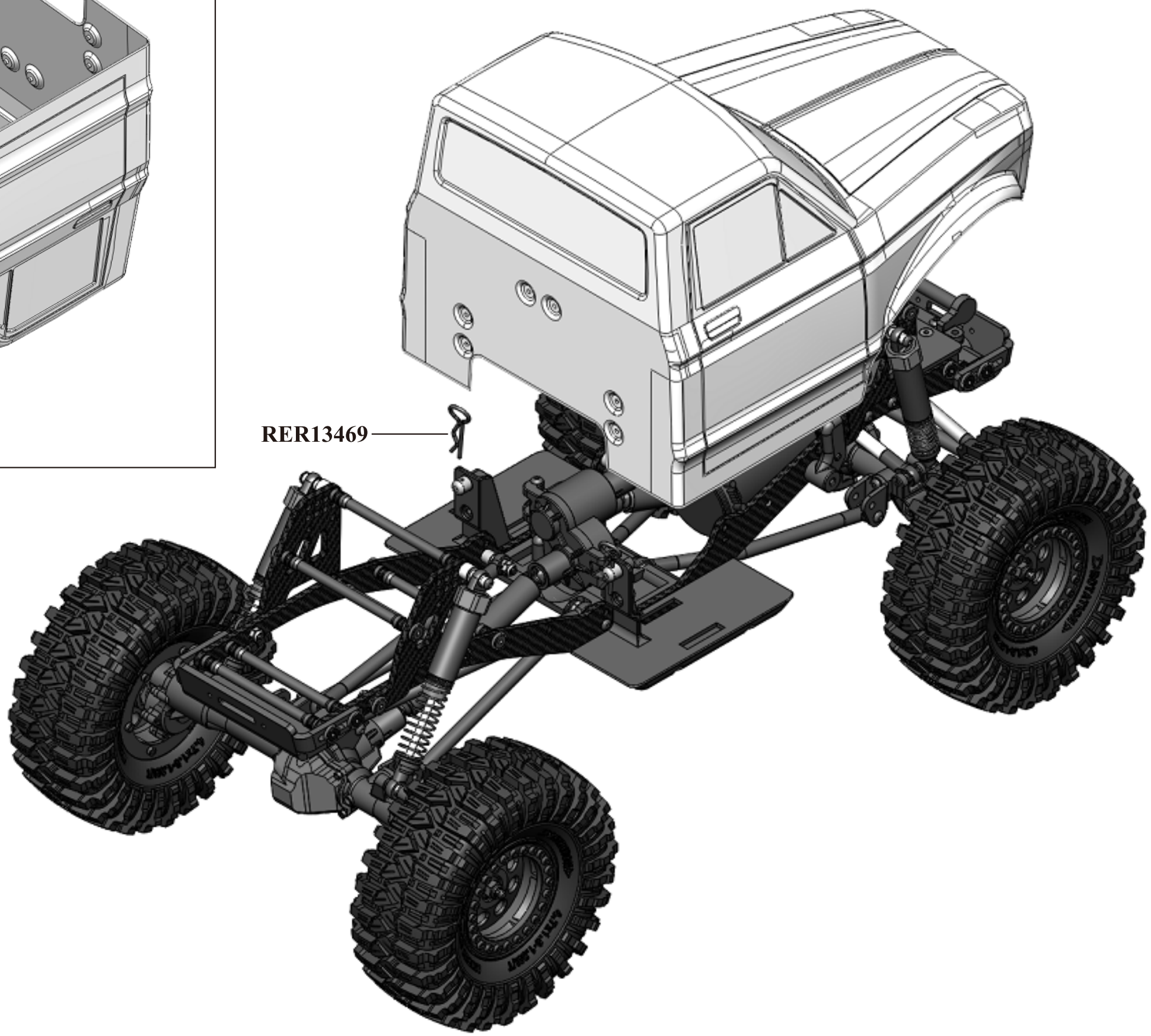
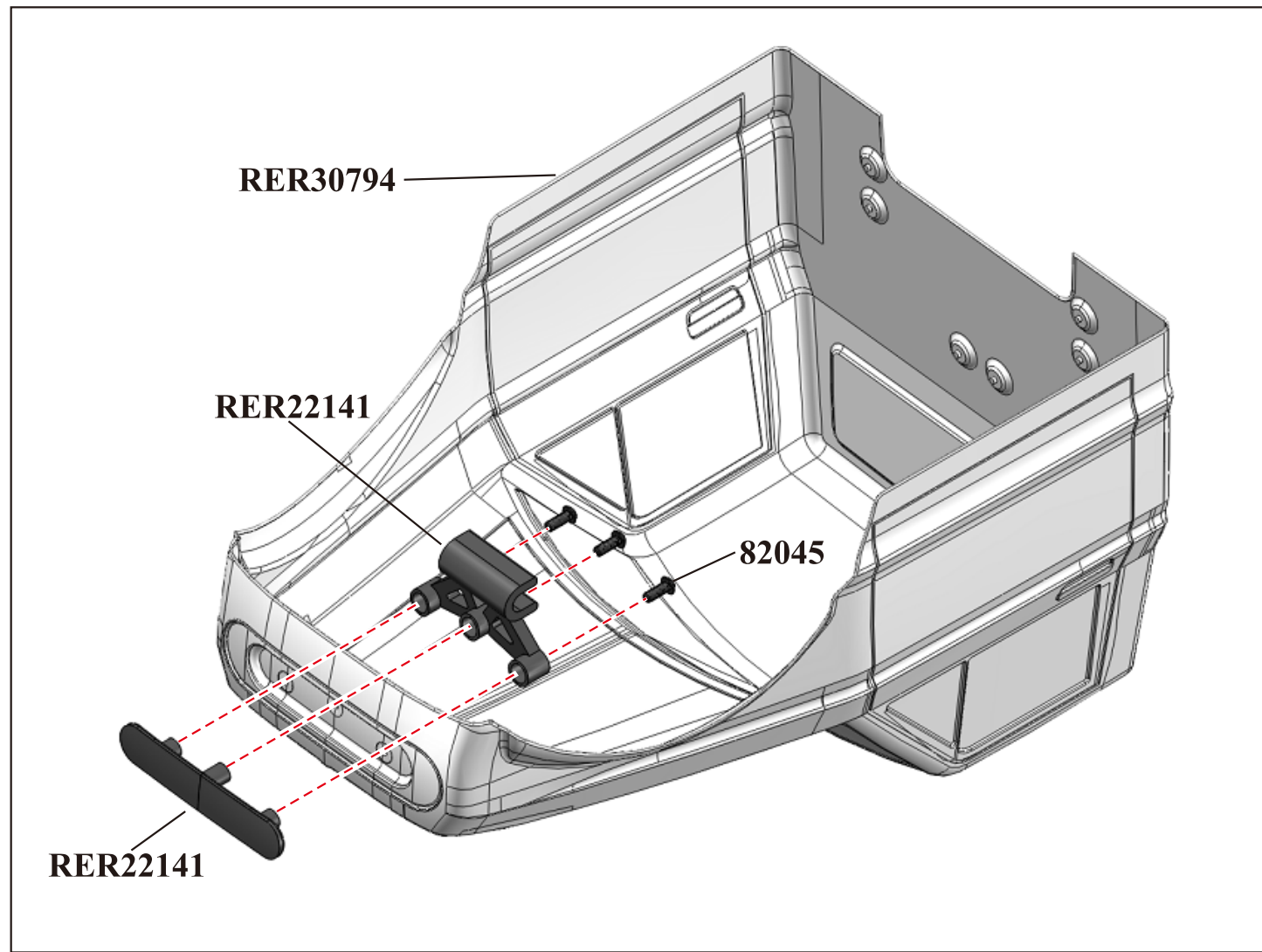



**[www.redcatracing.com](http://www.redcatracing.com)**

Follow us on social media

Take a photo, create a video, post and share your Redcat experience.

Stay up to date on the latest Redcat news, products, and creative content. While these profiles are not customer service channels, you might find that one of our subject experts or another member of the community is able to assist you. If you have an issue or need technical and or product support, please reach out to Redcat directly through our website.

-  <https://www.facebook.com/RedcatRacing>
-  <https://www.instagram.com/redcatracing/>
-  <https://www.youtube.com/RedcatRacing>
-  <https://twitter.com/RedcatRacing>
-  <https://www.pinterest.com/redcatracing/>
-  <https://www.tiktok.com/@redcatracing>

**IMPORTANT LINKS:**

- To view the full length manual with ESC guide, Radio guide, exploded views and parts lists, go to: [www.redcatracing.com/pages/manuals](http://www.redcatracing.com/pages/manuals)
- Link to electric vehicles manual:  
[www.redcatracing.com/manuals/ELECTRIC-MANUAL.pdf](http://www.redcatracing.com/manuals/ELECTRIC-MANUAL.pdf)

