



1/16 HIGH-PERFORMANCE 4WD RACING CAR
**OPERATING
INSTRUCTIONS**

FULL PROPORTIONAL REMOTE CONTROL UDIRACING SERIES

V1.0



*This product is suitable for users over 14 years old.
Please read this instruction manual carefully before use.*

**Important
Notice**

Our company's products are improving all the time, design and specifications are subject to change without notice. All the information in this manual has been carefully checked to ensure accuracy, if any printing errors, our company reserve the final interpretation right.

THANK YOU

- Thank you for choosing this product. The remote control model is designed to be fun to drive and uses high quality parts to improve durability and performance. The instruction manual you are reading is to make the product easier to understand and explain more thoroughly. We hope you enjoy this remote control model car. If you have any problems or need help, please call us and we will try our best to help you. You can also contact us through the following website: www.udirc.com.
- This is a radio control model product, not a toy! which needs regular maintenance to obtain the best performance. If you don't do regular maintenance, it can affect performance. We have all the necessary parts and accessories to ensure that your vehicle maintains its best performance.
- The warning or attention symbol will alert you to potentially dangerous steps. Please read and understand the instructions carefully before proceeding.



WARNING



ATTENTION

Failure to follow these instructions may result in injury to yourself or others. You may also cause property damage or model damage.



WARNING

- The model must stop immediately and check for the reasons when it is operating abnormal.
- Keep in mind that people around you may also operate a radio control model.
- The motor is a heating part, please do not touch it.
- If you don't use the model for a long time, please raise the chassis to let the wheels hang in the air.
- Please keep the package or instructions as they contain important information.



- The product contains small and sharp parts. Keep away from children.



- Be sure to read the instruction manual in detail, or ask for the person with experience in operation, and read with the guardian if necessary.

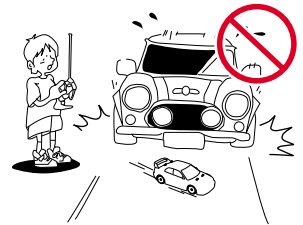

- DO NOT operate in public streets or crowded places to avoid accidents.



- Cutters, nippers and screwdrivers need careful handling.

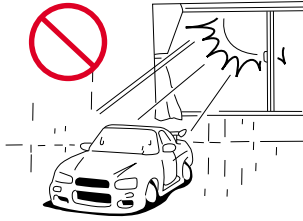

- DO NOT put the model in high temperature, humidity and direct sunlight.

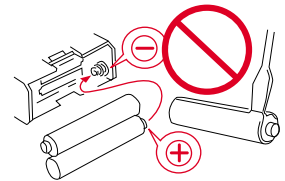

- Please don't reverse contact or disassemble the battery, as this way will cause the battery to explode.



WARNING

Before Operation

- Read the instruction manual in detail, or ask for the person with experience in operation, and read with the guardian if necessary.
- Make sure all screws and nuts are properly tightened.
- The remote control and the vehicle should always use the battery with saturated power to avoid losing control of the model.
- Please make sure that the throttle trigger is in the center position.

During Operation

- First turn on the power of the remote control, and then turn on the power of the model.
- Use this product only in open areas (>5*5m) without pedestrians.
- DO NOT put fingers or any objects inside rotating and moving parts.

After Operation

- First turn off the model power, then turn off the remote control power. And take out the battery.
- Daily maintenance is required after the model is used.



Battery safety

- Please read and observe all precautions before use. Improper use of battery may cause danger.
- It is normal for the battery to heat up after operation. Please be careful when handling the battery. If the wire is worn, it is easy to short circuit and cause fire.
- Wasted li-ion battery must not be placed with household trash. please contact local environmental or waste agency or the supplier of your model or your nearest li-ion battery recycling center.

- 1) After use, please disconnect the power supply and pull out the plug;
- 2) Remove the battery from the model before charging;
- 3) DO NOT charge the battery when it is bulging or expanding;
- 4) Keep away from damp, corrosive environment and heat source;
- 5) Please charge the battery under adult supervision;
- 6) Pay attention to the polarity of the battery when installing or replacing the battery;
- 7) Different types of batteries or old and new batteries should not be mixed;
- 8) DO NOT short circuit any terminals;
- 9) DO NOT short circuit, decompose or put the battery into fire;
- 10) Please use the attached special charger to charge the battery.

WARNING

Warning: The product should only be used by adults and children over 14 years.

Adult supervision is required for children under 14 years.

Hinweis: Dieses Produkt ist für die Erwachsene und die Kinder ab 14 Jahren.

Die Kinder unter 14 Jahren müssen von Erwachsenen beaufsichtigt werden.

Avertissement: Ce produit est destiné aux adultes et aux enfants de plus de 14 ans.

Les enfants de moins de 14 ans doivent être surveillés par des adultes.

Avvertimento: Questo prodotto è destinato all'uso per i adulti e bambini di età superiore ai 14 anni.

I bambini di età inferiore ai 14 anni devono essere sorvegliati da un adulto.

Advertencia: Este producto es para adultos y niños mayores de 14 años.

Los niños menores de 14 años deben ser supervisados por adultos.

警告: この製品は、大人と14歳以上の子供には使用対象です。

14歳未満の子供は大人の監視が必要です。

اماع 14 نس قوف لافسطل او ني غلابلا لبق نم طقف جت نجلما مادختسا بجي ريذحت

اماع 14 نس نود لافسطل بولطم رابنكنا فارشا.



DANGER!

Only suitable
for age 14+

Product maintenance

When not in use, remove the battery from the model and transmitter.



Please remove the sediment and dirt on the car completely and must be kept dry after play.



Apply lubricating oil to external metal parts.

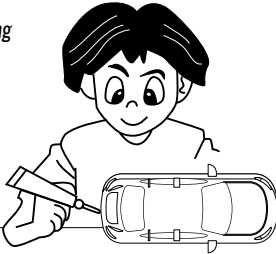

Please separate the car and battery when not in use.

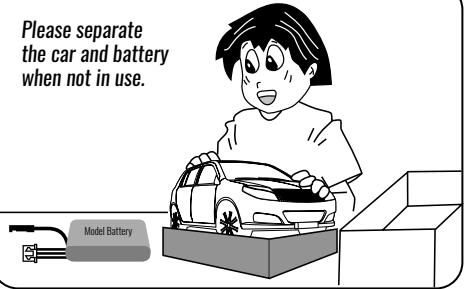

Troubleshooting

Cause	Solution
Remote control car doesn't work	When the battery is low, charger it in time or replace it with new battery.
	Please make sure the wheel or drive shaft is entangled by debris and remove it.
	The motor may have reached the expiration date, replace with the same motor.
	Please keep the car within effective control distance.
	When the battery of the transmitter is low battery, please replace it in time.
	Check whether all parts of the model car are damaged and replace them.
	High temperature protection is triggered when the ESC's temperature is too high. Please pause for 10 minutes before using.
Long frequency matching time	The signal is disturbed, restart the car and the transmitter.
Operation delay	Please make sure there are obstacles or interferences.
The vehicle moves forward (backward) automatically or makes a sound of "en...."	Restart the transmitter
The indicator of the transmitter is not bright	Please make sure the battery is installed correctly or replace it with a new one.
	If the transmitter doesn't work, please replace it with a new one.
The steering of the model car has no force or function	Increase the percentage of steering.
	Please make sure the steering is it include the sundries or some parts damaged.

Model Car Summary

Accessories vary by model, the products obtained from sales shall prevail.

Regular version

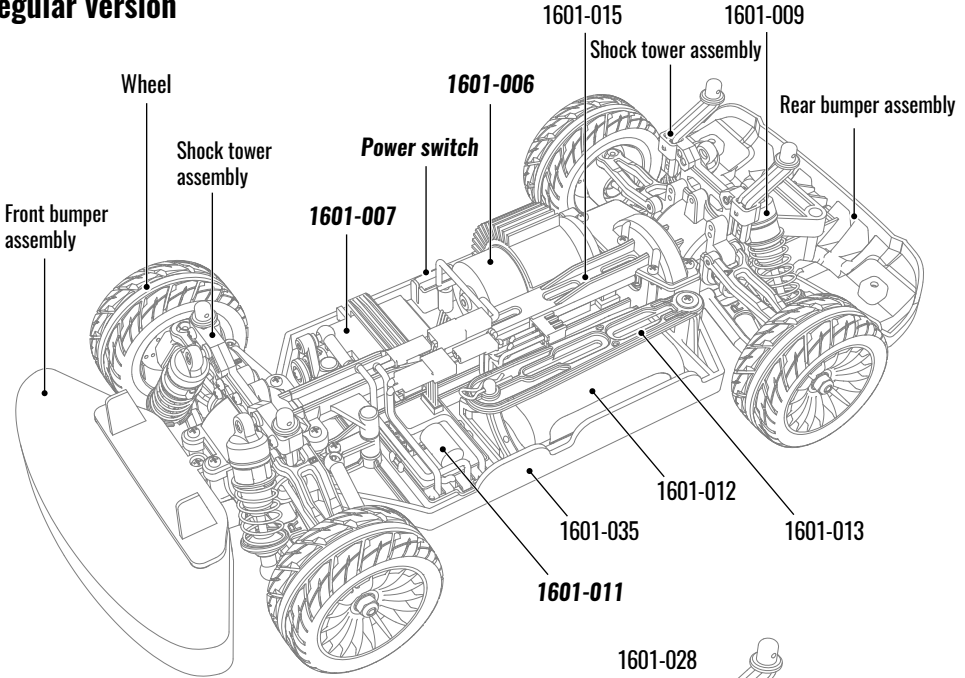

Professional version

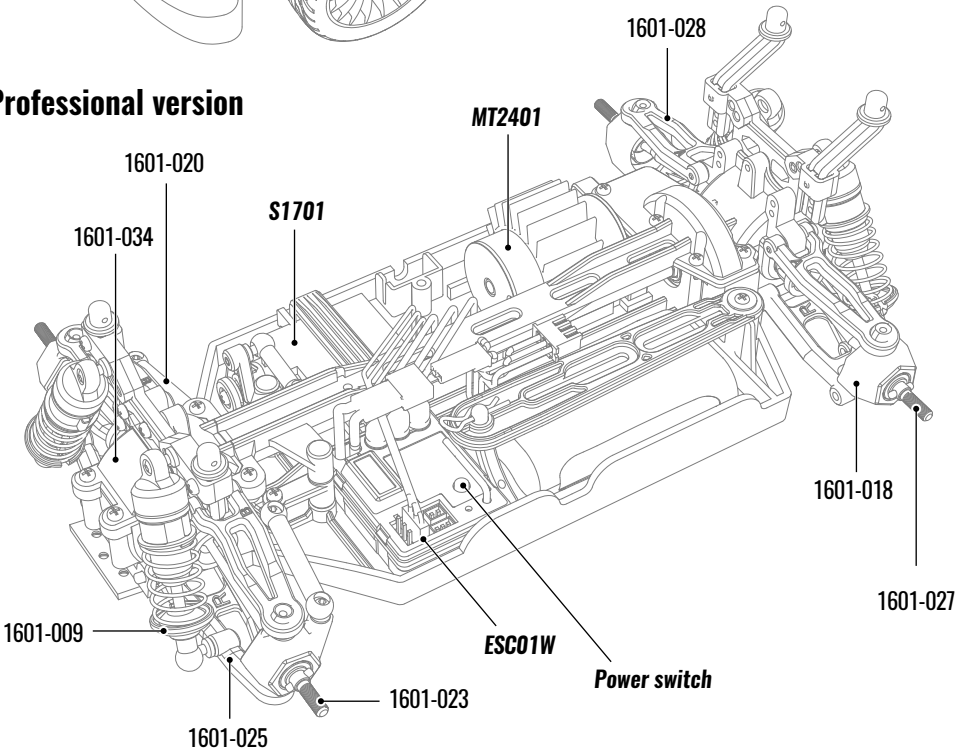

Electronic speed controller

1601-011

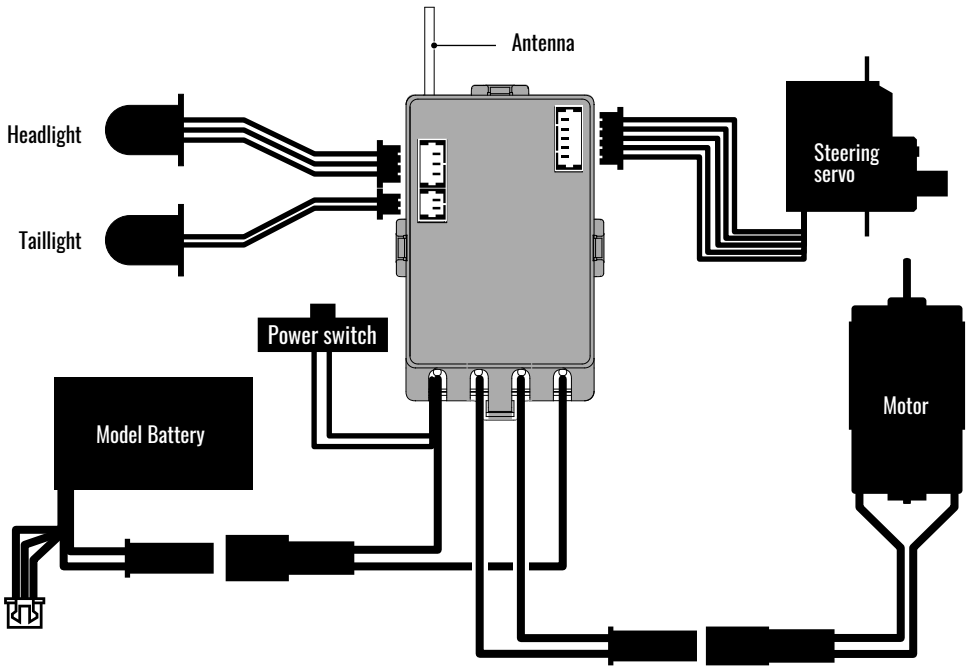

ESC01W

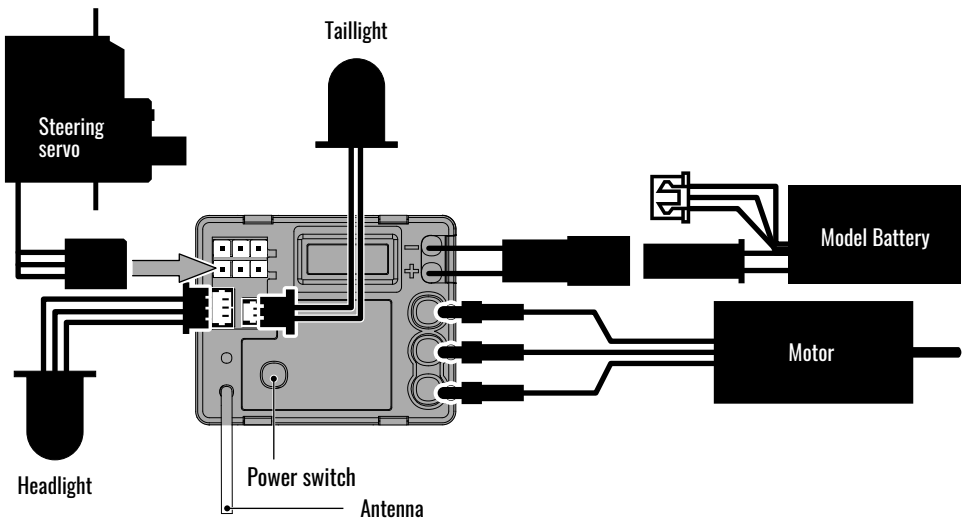

Preparation of transmitter

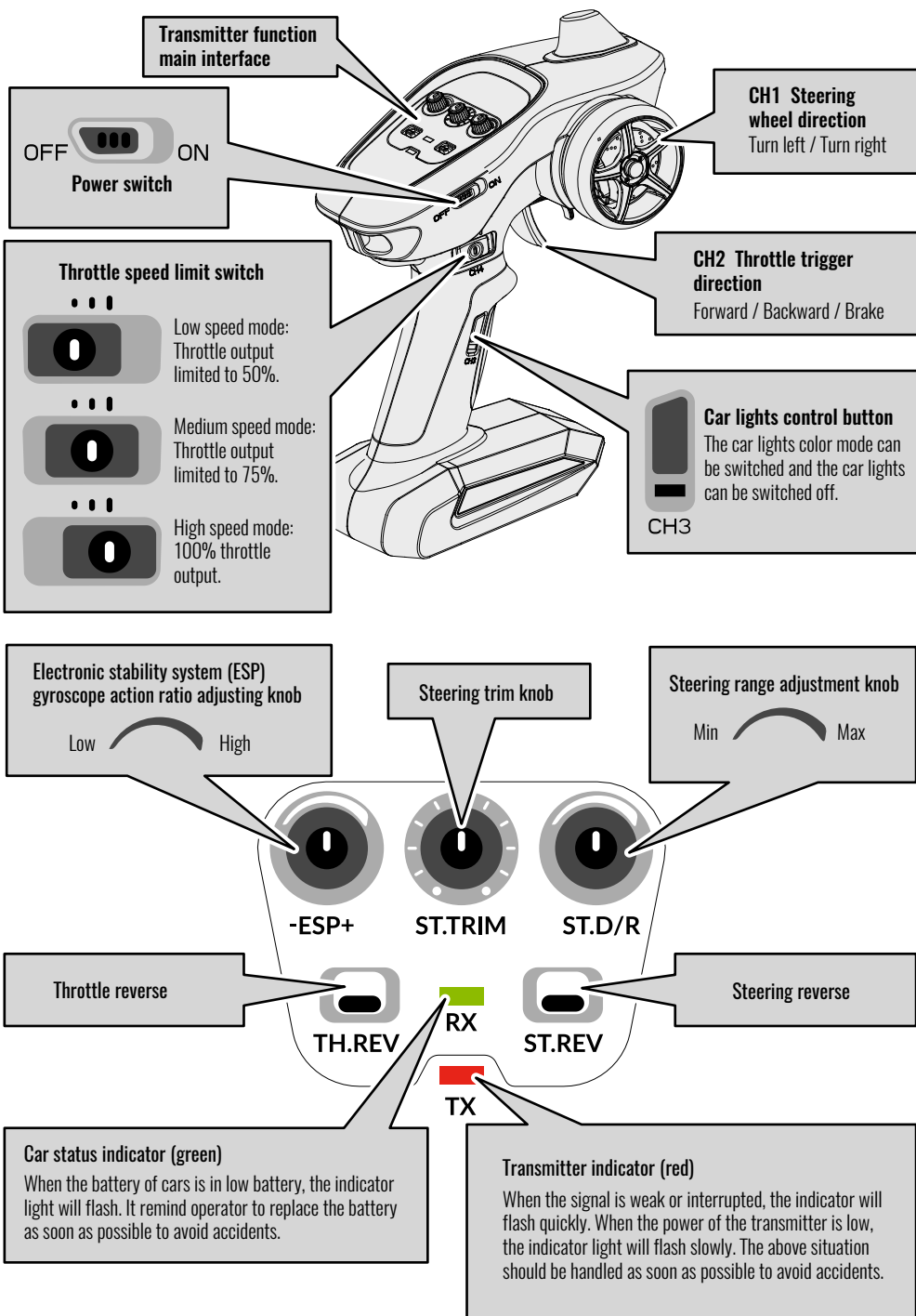

Adjustment of gyroscope action ratio

This product has the function of ESP car stability system, which can effectively correct the car attitude and direction when the car skids or loses control. The function and sensitivity of the car gyroscope sensor can be adjusted through the ESP knob of the transmitter.



-ESP+

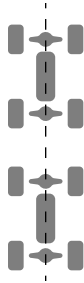

The action ratio decreased



The action ratio increases



Steering range adjustment

The steering range adjustment knob can be used to adjust the left and right steering angle of the car.



ST.D/R



Minimum steering angle



Maximum steering angle

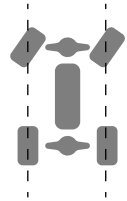
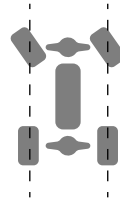

Steering trim

When the steering wheel is in the center position, if the car can not drive in a straight line, please use the steering trim knob to adjust and correct the left and right directions of the front wheels.

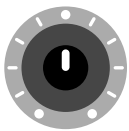

ST.TRIM

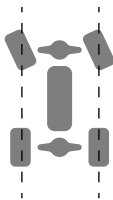

When the front wheel is left, the knob rotates to the right.



When the front wheel is right, the knob rotates to the left.

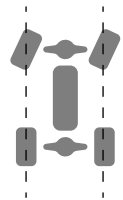

ATTENTION

- 1) There is no ESP function when the remote control car retreats.
- 2) When the remote control car is moving forward, it is necessary to pull the throttle trigger backward to reach more than 30% of the stroke before the gyroscope starts to work.
- 3) With the increase of car speed, the gyroscope action ratio also increases synchronously.

Assembly of the transmitter battery

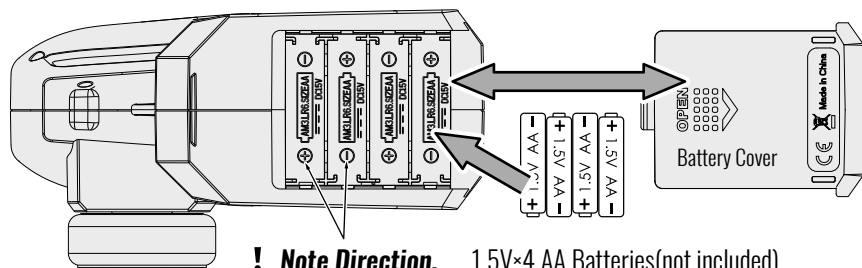

Open battery cover at the bottom of transmitter. Install batteries.
Follow the direction of batteries designated in the inside of the battery box.

Model Battery charging

The battery contains less power when leaving the factory, so it must be charged and saturated before use.

Connect the attached charger with the model battery charging input port, and then connect other USB output ports. When charging, the charging indicator is flashing, and the indicator is always on after charging. Do not put the battery in the model when charging. The battery must be cooled before charging.

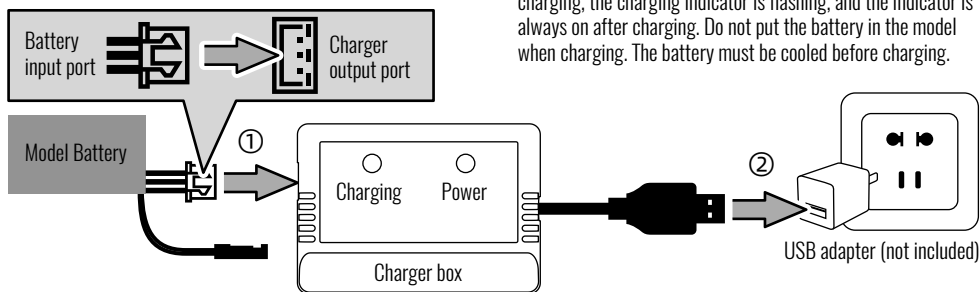

Warning: someone must be watching while charging.
Please use the charging box provided with the product and make sure it is connected properly.

Assembly of model battery

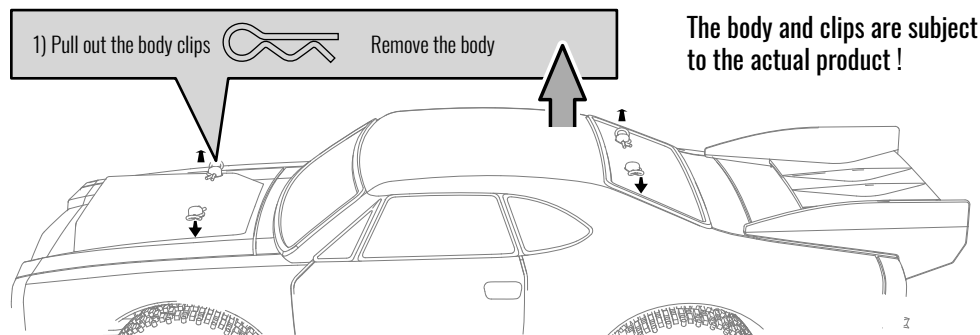

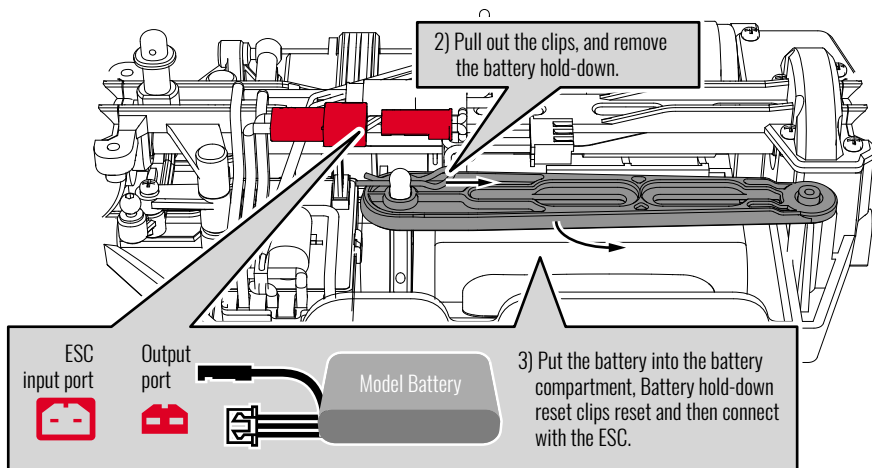

4) Reset the bodyshell

Operational guidance

1 > Frequency matching

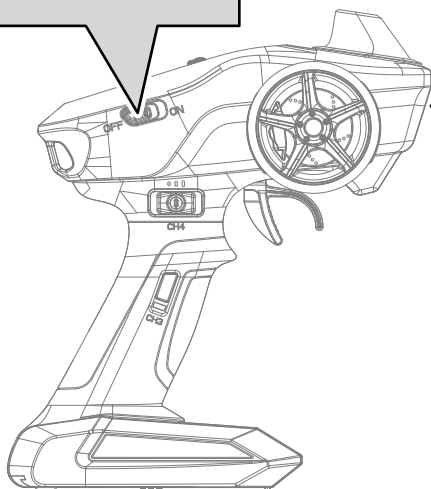
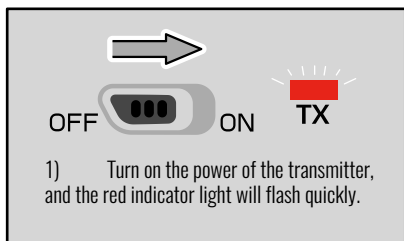

! Consistent direction

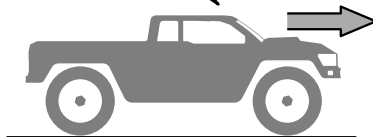

Place the model on level ground

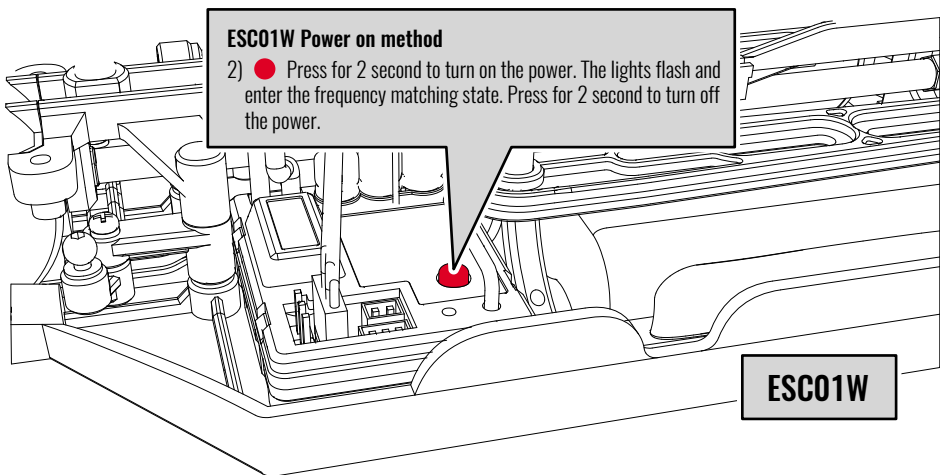
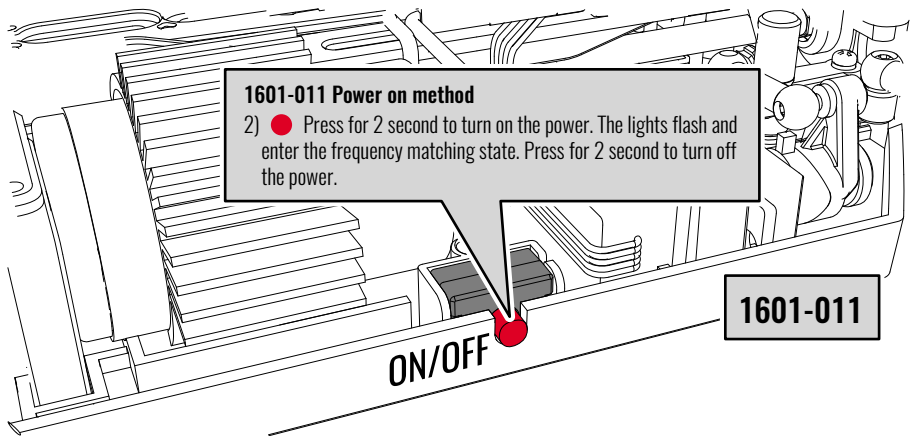

After the car power is turned on, the transmitter and the car will carry out automatic frequency matching. When the indicator light of the transmitter and the car lights are always on, the frequency matching is successful. In the process of frequency matching, the car lights will flash rapidly. At this time, the gyroscope is being calibrated automatically. Please place the car on the level ground to complete this operation. After calibration, the car lights return to normal.

2>

Manipulation method

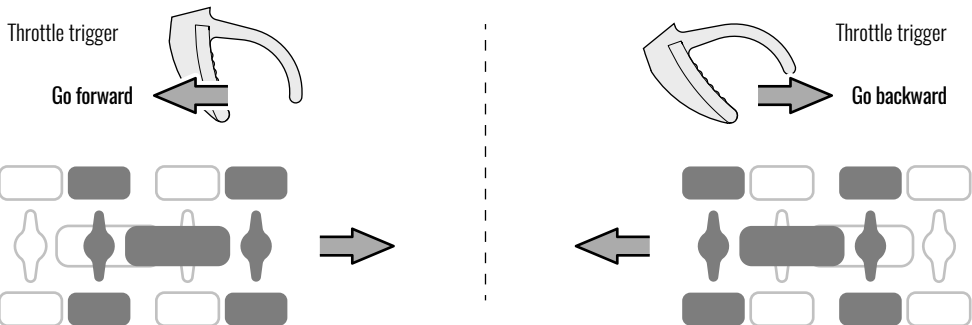

Steering wheel

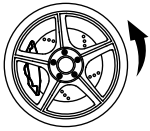

Turn left

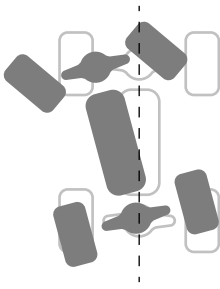

Steering wheel



Turn right

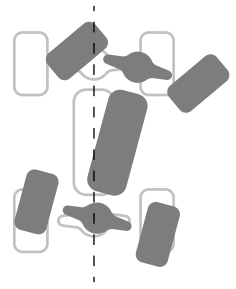

Turn left and move forward

Throttle trigger

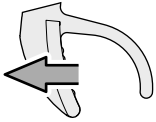

Go forward

Steering wheel

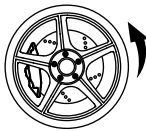

Turn left

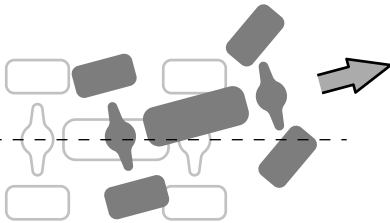

Turn right and move forward

Throttle trigger

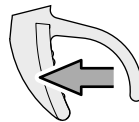

Go forward

Steering wheel

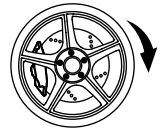

Turn right

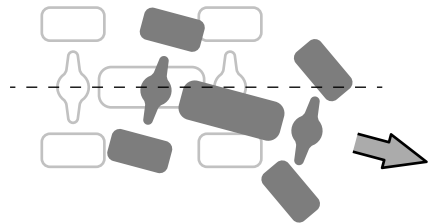

Turn left and move backward

Throttle trigger

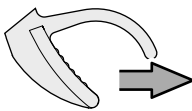

Go backward

Steering wheel

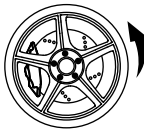

Turn left

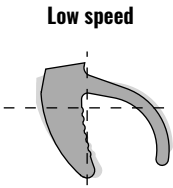

Low speed

Pull the throttle trigger back gently and the car will move forward slowly.

High speed



The throttle trigger is pulled to the maximum, and the car moves forward quickly.

Turn right and move backward

Throttle trigger

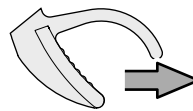

Go backward

Steering wheel

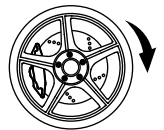

Turn right

Brake/Backward

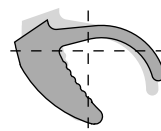

When the car is moving forward, the throttle trigger is pushed forward and the car stops moving. After the throttle trigger returns to the middle position, it pushes forward again, and the car moves backward.

Parts exploded view

! Accessories vary by model, the products obtained from sales shall prevail.

Installation of wheels

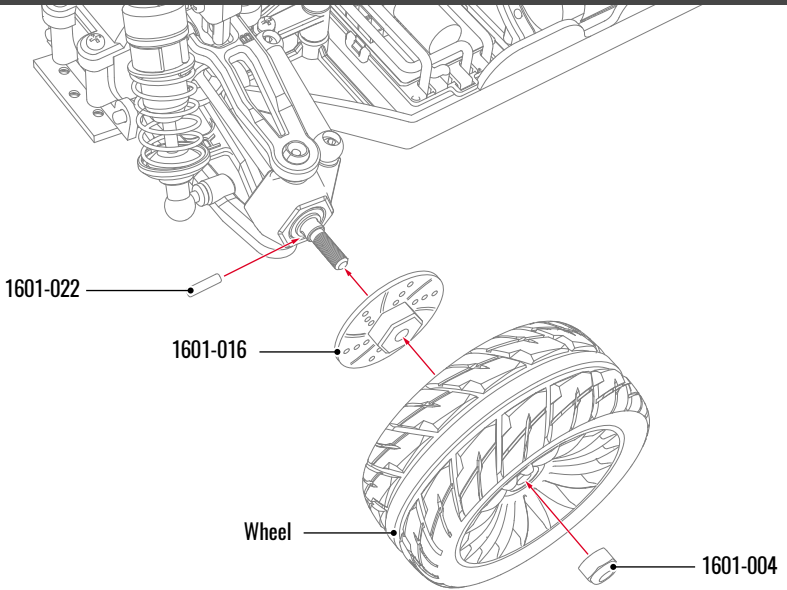

Front and rear shock absorbers

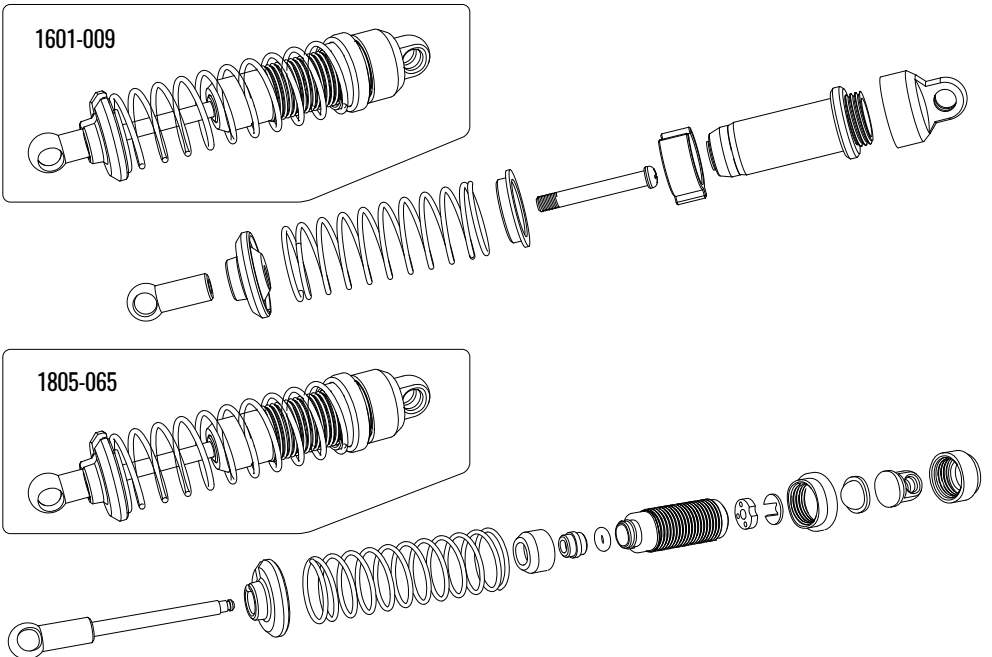

Assembly of front suspension arm

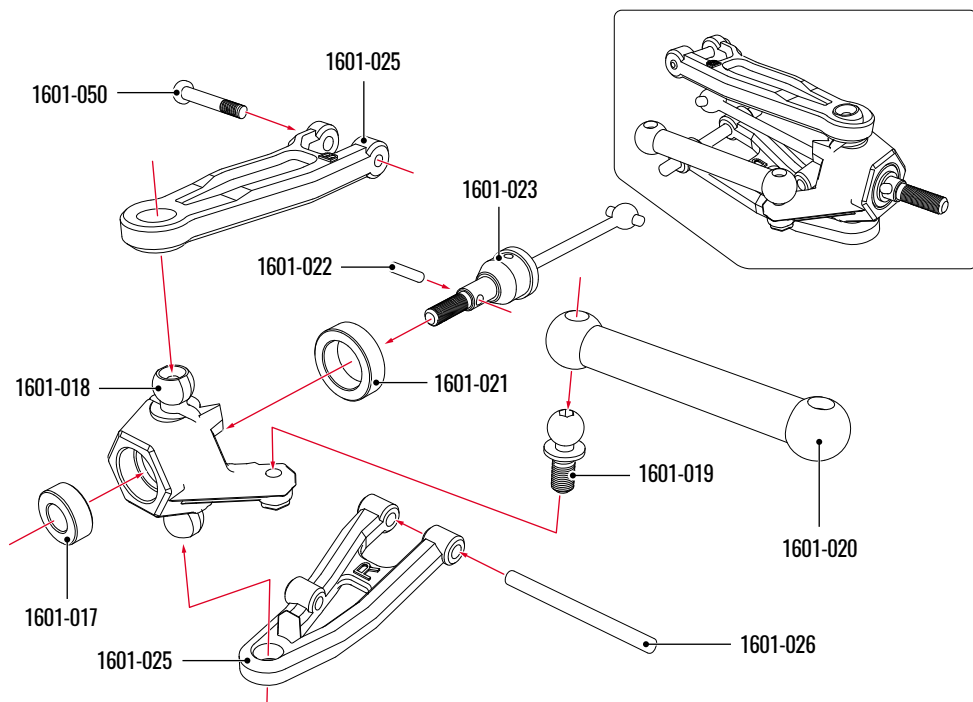

Assembly of rear suspension arm

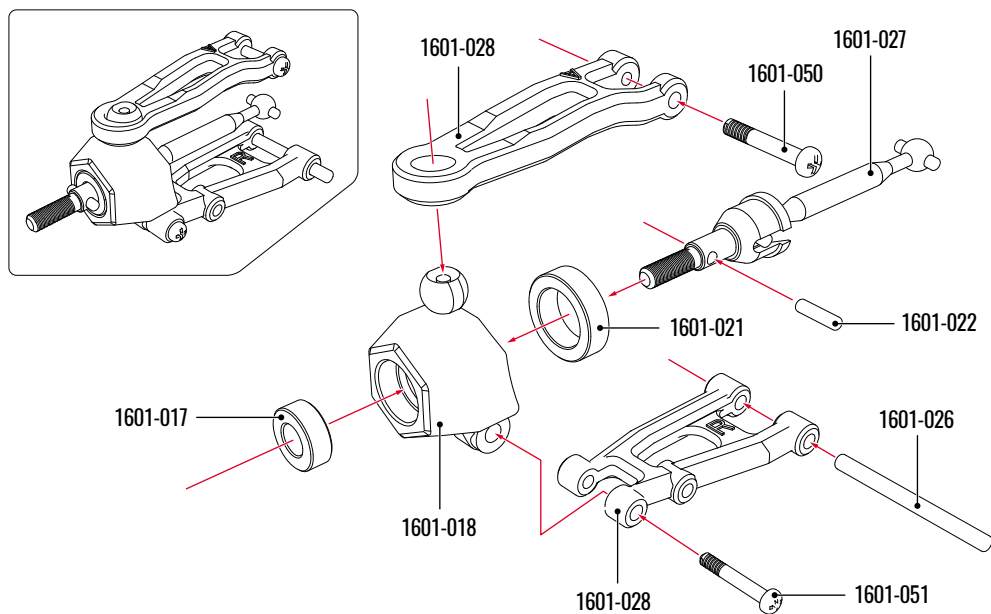

Assembly of front bumper

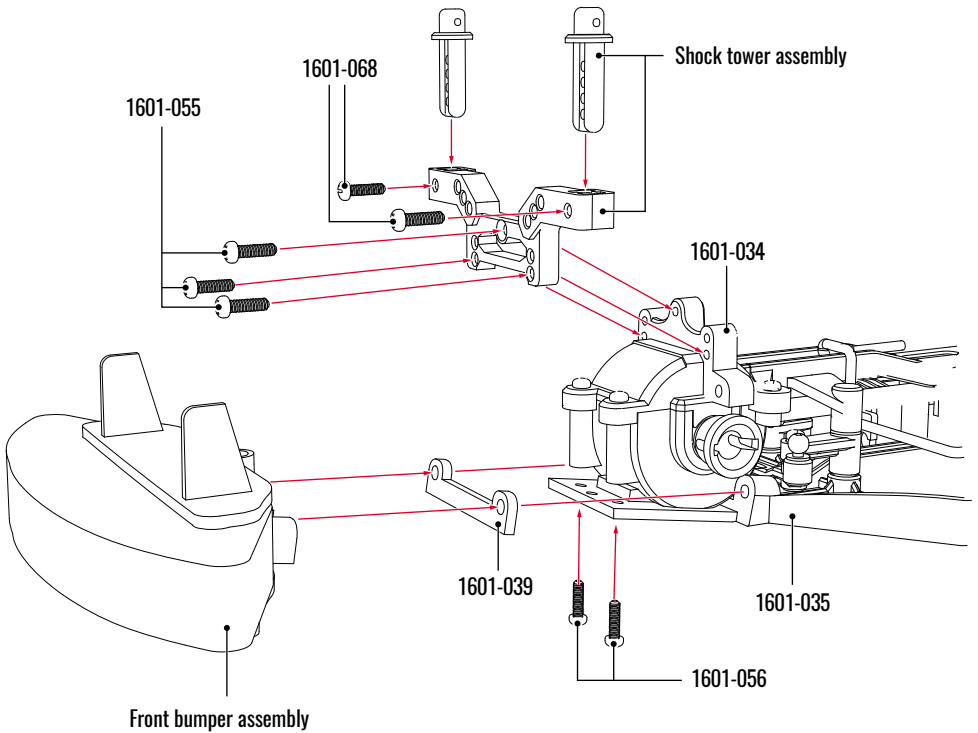
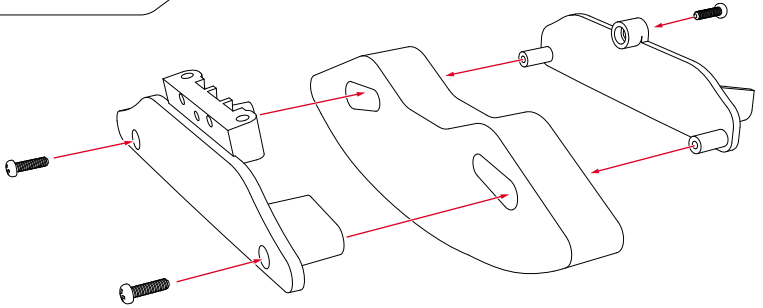
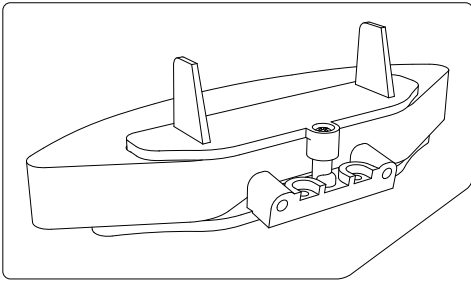

Assembly of rear bumper

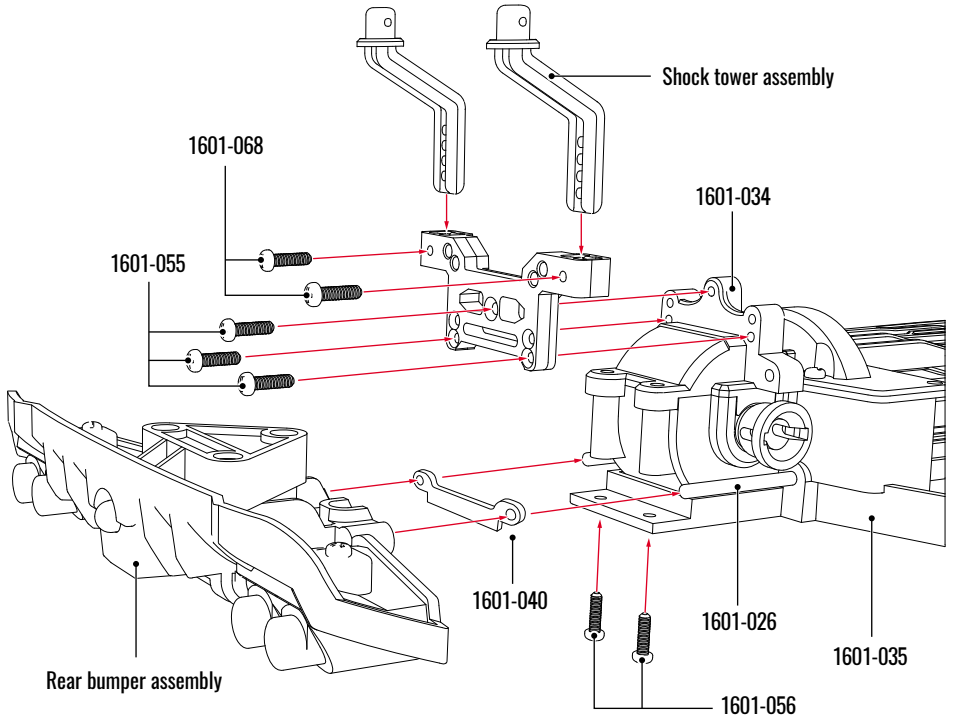
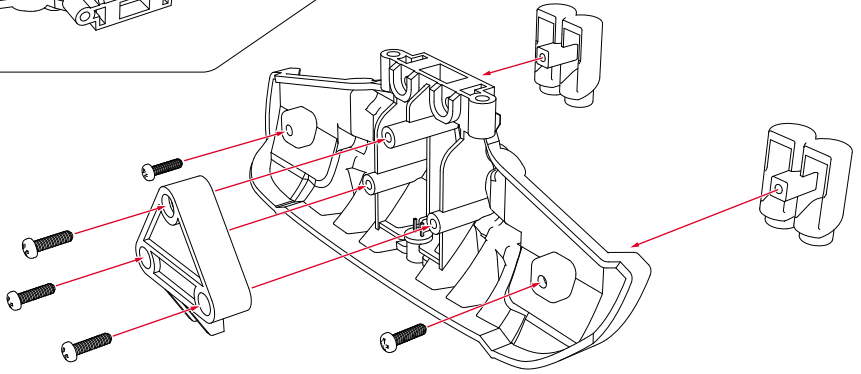
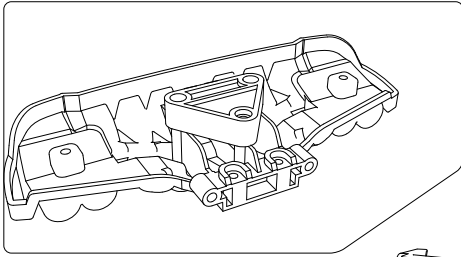

Assembly of steering servo

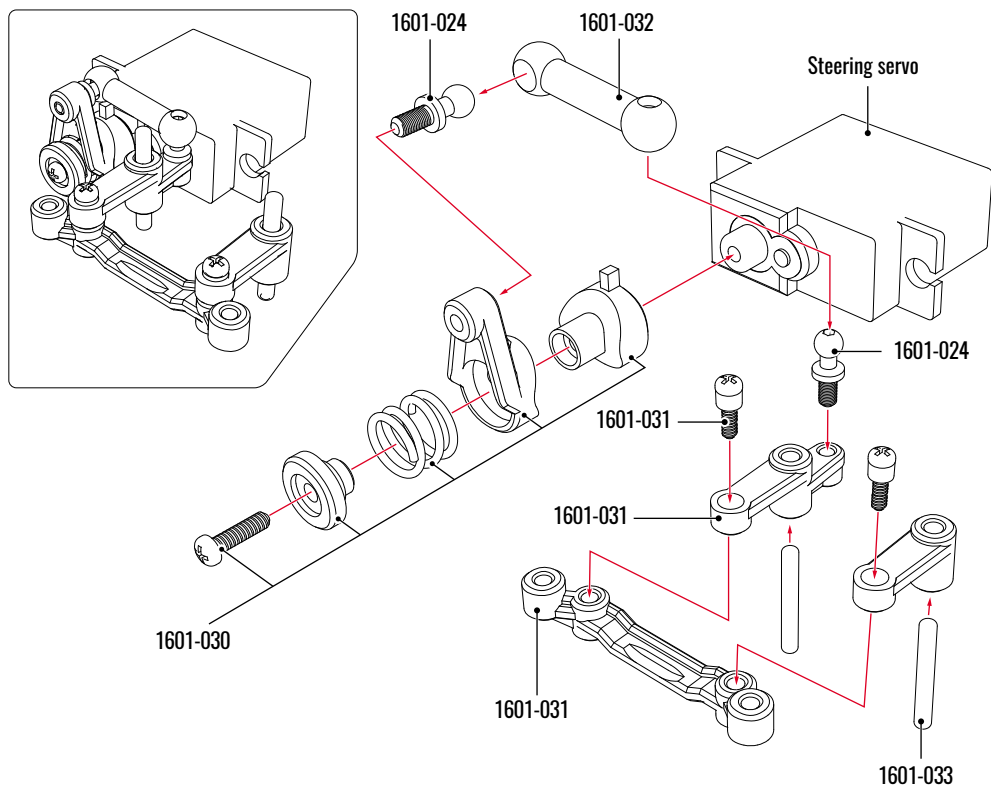

Assembly of front(rear) differentials

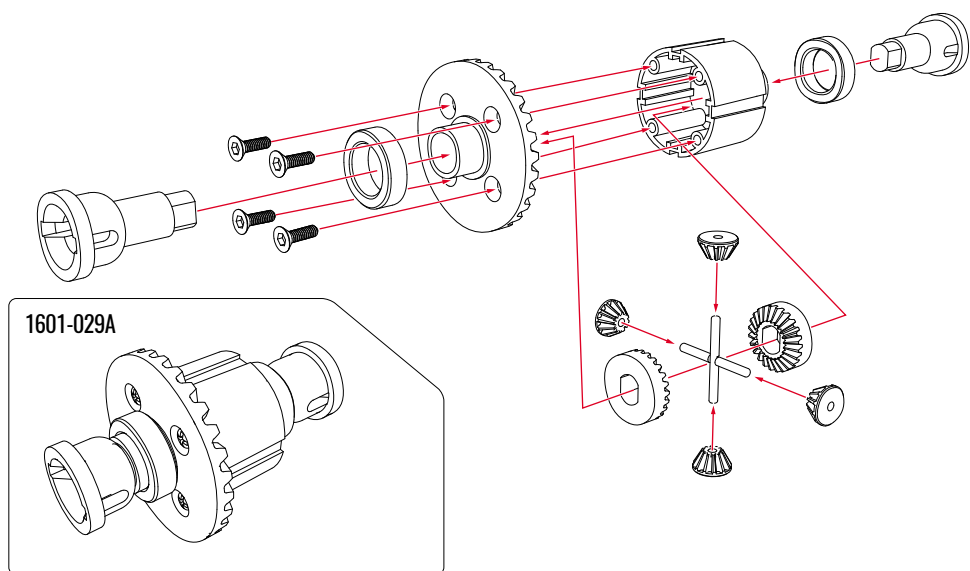

Main propeller shaft system

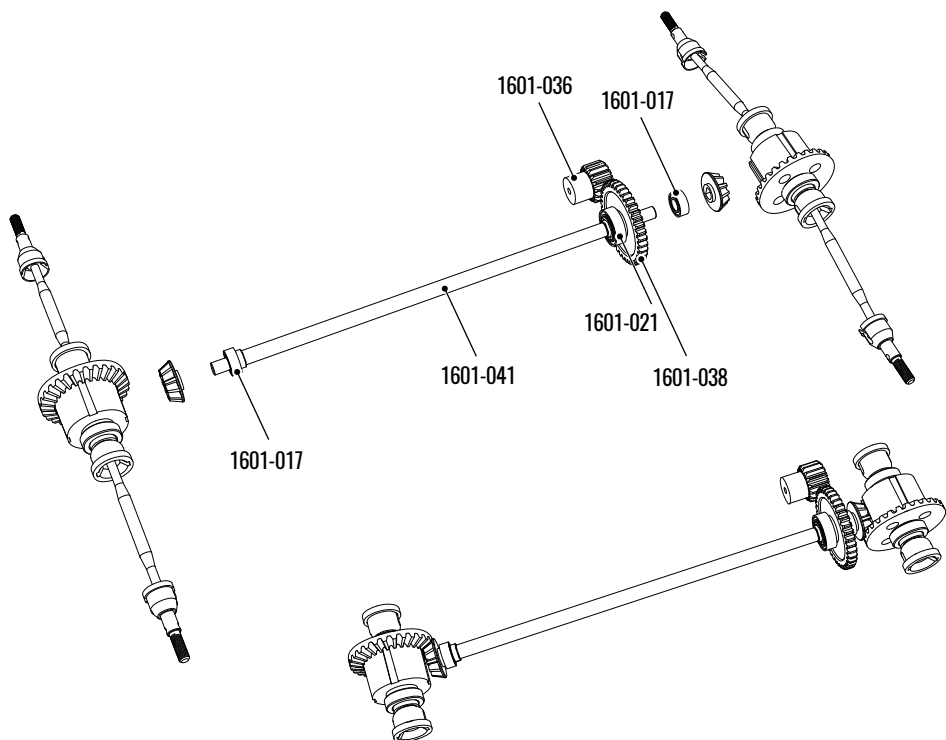

Assembly of chassis

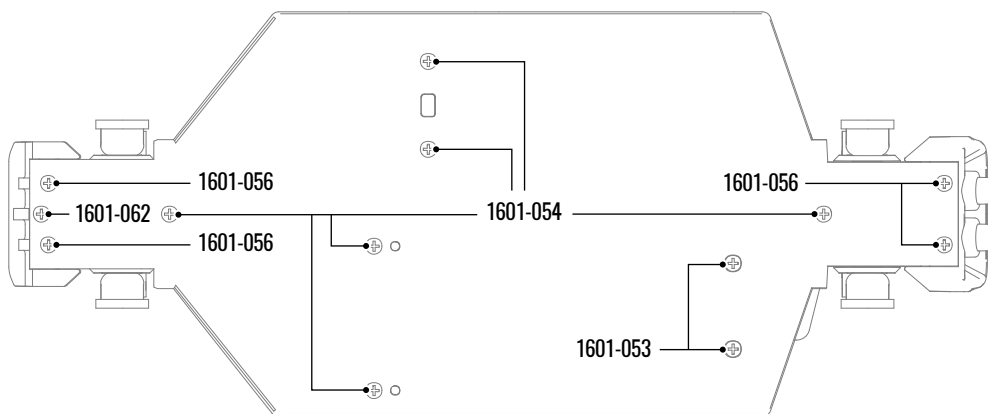

Buyable accessories

The picture is only for reference, please make the object as the standard.



1601-002
Body clips × 4



1601-003
Headlight group



1601-042
Taillight group



1601-005#A
Wheel × 4



1601-005#B
Wheel × 4



1608-005A
Wheel × 4



1608-005B
Wheel × 4



1604-005A
Wheel × 4



1603-005A
Wheel × 4



1601-006
Motor assembly(390)



MT2401
Motor assembly(Brushless)



1601-007
Steering servo
(Only for 390 motor)



S1701
Steering servo
(Only for brushless motor)



1601-009
Front & Rear shock
absorber



1601-065
Front & Rear shock
absorber(Metal)



1601-011
Electronic speed controller
(Only for 390 motor)



ESC01W
Electronic speed controller
(Only for brushless motor)



1601-012
Model battery









1601-013
Battery hold-down

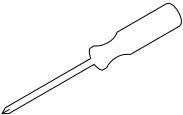
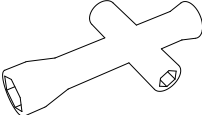

1601-015
Upper chassis

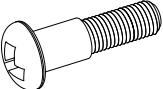
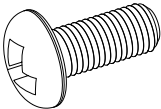
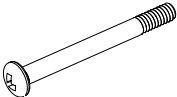
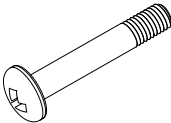
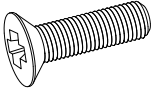
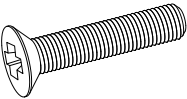
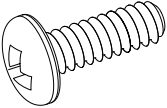
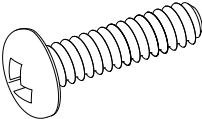
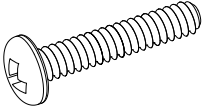
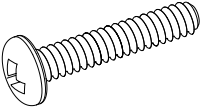
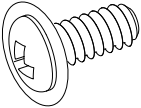
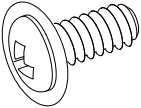
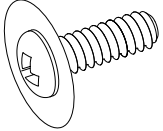
			
1601-016 Wheel adapters × 4	1601-018 Front & Rear wheel carriers assembly	1601-020 Steering linkage	1601-023 Front CVD driveshaft assembly × 2
			
1601-025 Suspension arms (front)	1601-027 Rear driveshaft assembly × 2	1601-028 Suspension arms (rear)	1601-029 Differential assembly
			
1601-063 Differential assembly(Metal)	1601-030/032 Servo saver/ Rudder connecting rod	1601-031 Steering bellcrank	1601-066 Rudder connecting rod
			
1601-034 Differential housing	1601-035 Chassis	1601-036 Motor gear	1601-037 Motor mounts
			
1601-038 Main spur gear	1601-039/040 Bulkhead tie bars (front & rear)	1601-064 Metal Differential Gear	1601-041 Main driveshaft ø6.25×216mm

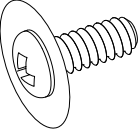
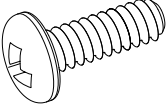
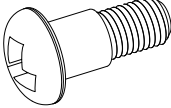
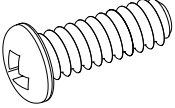
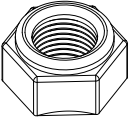
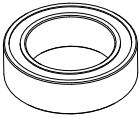
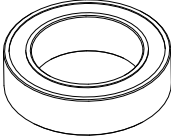
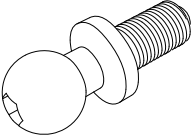
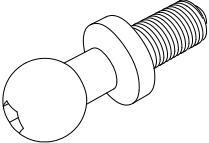
			
1601-043 Charger	1601-044 Transmitter		
			
1601-045 Cross screwdriver	1601-046 Hexagon nut wrench 2-4mm	1601-047 Hex wrench	1601-048 Ø2.5×11.8mm PM Shoulder screws ×8
			 Only for 390 motor mounts
1601-049 Ø2.5×5mm PM Screws ×8	1601-050 Ø2×13mm PM Screw pin set ×8	1601-051 Ø2.5×16.5mm PM Screw pin set ×8	1601-052 Ø2.5×8.5mm KM Screws ×8
			
1601-053 Ø2.5×11.5mm KM Screws ×8	1601-054 Ø2.3×8mm PB Screws ×8	1601-055 Ø2×10mm PB Screws ×8	1601-056 Ø2.3×14mm PB Screws ×8
			
1601-057 Ø2.5×15mm PB Screws ×8	1601-058 Ø2.3×Ø5×4mm PB Screws ×8	1601-059 Ø2.3×Ø5×6mm PB Screws ×8	1601-060 Ø2.3×8×Ø8mm PB Screws ×8

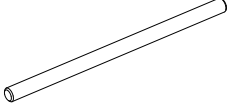
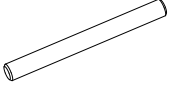
			
1601-061 Ø2.3×5×Ø7mm PB Screws ×8	1601-062 Ø2.3×6mm PB Screws ×8	1601-067 Ø4×6.6mm PM Shoulder screws ×8	1601-068 Ø2×8mm PB Screws ×8
			
1601-004 M3 Hex flanged nylon insert lock nut ×4	1601-017 Ø8×Ø4×3mm Ball bearing ×4	1601-021 Ø12×Ø8×3.5mm Ball bearing ×4	1601-019 Ø2.5×10mm Pivot balls ×4
			
1601-024 Ø2.5×12mm Pivot balls ×4	1601-022 Ø1.8×6.8mm Pin ×4	1601-026 Ø2.5×32mm Pin ×4	1601-033 Ø2.5×21mm Pin ×4

FCC Note

This equipment has been tested and found to comply with the limits for a Class B digital device, pursuant to Part 15 of the FCC Rules. These limits are designed to provide reasonable protection against harmful interference in a residential installation. This equipment generates uses and can radiate radio frequency energy and, if not installed and used in accordance with the instructions, may cause harmful interference to radio communications. However, there is no guarantee that interference will not occur in a particular installation. If this equipment does cause harmful interference to radio or television reception, which can be determined by turning the equipment off and on, the user is encouraged to try to correct the interference by one or more of the following measures:

- *Reorient or relocate the receiving antenna.*
- *Increase the separation between the equipment and receiver.*
- *Connect the equipment into an outlet on a circuit different from that to which the receiver is connected.*

WARNING: Changes or modifications not expressly approved by the party responsible for compliance could void the user's authority to operate the equipment.

FCC Notice

The equipment may generate or use radio frequency energy. Changes or modifications to this equipment may cause harmful interference unless the modifications are expressly approved in the instruction manual. Modifications not authorized by the manufacturer may void user's authority to operate this device.

This device complies with Part 15 of the FCC Rules. Operation is subject to the following two conditions:

- (1) This device may not cause harmful interference.
- (2) This device must accept any interference received, including interference that may cause undesired operation.

FCC Radiation Exposure Statement

The device has been evaluated to meet general RF exposure requirement.
The device can be used in portable exposure condition with out restriction.



Demo video



Operation guide
download



Manufacturer: UDIRC TECHNOLOGY CO., LTD

Address: Guangfeng Industrial Zone, Guangyi Street, Chenghai District, Shantou City, Guangdong Province, CN

MADE IN CHINA